



TPC



INNOVATION • RELIABILITY • QUALITY
2018 **Catalog U.S.A**

TPC

OUR VISION

A Preferred Company

To create a quality environment where people can work together to provide simple, creative solutions for the betterment of dentistry.

OUR MISSION

Continuous Improvement

We will manufacture innovative, high quality and cost effective dental products that enable distribution partners, dentists, hygienists, teaching institutions and government organizations throughout the world to perform efficient quality dental care. TPC provides innovative solutions and quality equipment that enables dental professionals to work together for the benefit of dentistry.

TABLE OF CONTENTS

Our Vision & Our Mission	Inside Front Cover
Terms & Conditions	1
Chairs & Delivery Units	2-21
Portable Dental Systems	22-25
Stools & X-Ray Chairs	26-28
Operatory Lights	29-31
Mobile Cabinets	32
Imaging Products & Accessories	33-42
Dental Handpiece & Parts	43-55
Handpiece Cleaning & Lubrication Systems	56
Curing & Bleaching	57-66
Scaling Products & Accessories	67-73
Ultrasonic Bath	74-77
Digital Amalgamator	78
Micro Motor & Handpiece	79
Disposable Micro Applicators	80
Disposable Air / Water Syringes	81
Disposable Prophy Angles	82
Disposable Evacuator tips	83
Lab Products	84
Disposable Prophy Cups & Brushes	85
X-Ray Film Holders & Utility Tray	86
Film Mounts	87-90
Autoclavable Air / Water Syringe Tips	91
Deluxe Autoclaveable Valves	92
Parts & Components	93-97
Order Form	Inside Back Cover

Customer Care (8:00 a.m. – 5 p.m. PST)
Customer Service Fax Orders
Technical Support
Sales Support
International Sales
Latin america sales
Shipping
Accounting
Customer Service
Ordering

1-626-810-4337
1-626-810-4245
service@tpcdental.com
sbeckley@tpcdental.com
dwang@tpcdental.com
alfonso@tpcdental.com
holly@tpcdental.com
vwang@tpcdental.com
customerservice@tpcdental.com
customerservice@tpcdental.com



Ordering Information:

When placing orders, please include the following information. All orders will be processed upon receipt of a faxed, mailed, or e-mailed hardcopy of the purchase order.

- Model and/or Part Number
- Quantity
- Requested Ship Date
- Shipping Instructions
- Description / Voltage
- Cancellations must be confirmed in writing
- Purchase Order Number
- All credit cards are accepted unless otherwise noted

Returned Goods:

All returns require prior authorization. Returns must be authorized by TPC within 7 days of date received by the customer.

- Contact Customer Service for Return Authorization Number
- Returned products are subject to a 25% restocking charge
- All returned goods must have Return Authorization Number
- All returned goods must be shipped prepaid
- All authorized returns must be received by TPC in original packaging, accessories, documentation and in original condition for credit considerations
- All outbound repair / warranty freight charges are the responsibly of the customer.
- No returns accepted after 14 days.

Special Orders:

- Special order items and custom made products are not returnable for credit

Minimum Orders:

- Orders less than \$50.00 will incur an additional \$5.00 handling charge.
- All drop ship orders will incur an additional \$5.00 fee.

Terms of Sale:

- Claims: All claims for merchandise received that are not in accordance with the original purchase order must be made within five (5) working days of the receipt of the merchandise. All merchandise is quality inspected and packaged in perfect condition. The common carrier assumes full responsibility for the safe delivery of all merchandise after it is removed from the F.O.B. shipping point. All claims for shortages, loss or damage must be documented and filed promptly with the freight carrier. Concealed damage must be reported to the freight carrier immediately upon discovery, with a request for inspection. If a request is made more than 15 days after the receipt of the merchandise, reasonable evidence must be submitted indicating that damage could not have occurred after delivery.
- All pricing in catalog is subject to change. Verify all pricing prior to placing order.

Warranty Information (All stated warranties are intended for USA market ONLY):

All of our products sold are guaranteed to be free from defects in workmanship and materials for one year from date of purchase, unless otherwise stated. TPC will repair or replace any defective part at no charge. TPC will not be responsible for labor charges or shipping charges to / from the TPC facility. This guarantee does not cover normal wear or stains on surface finish. The guarantee does not cover damage resulting from improper installation, misuse or accidents incurred in shipping and handling. All claims against the freight carrier must be initiated at the time the damaged items are received. The claim is the responsibility of the customer. We are improving our products on a continuous basis. We reserve the right to make modifications without the need for prior notification and are not obliged

Products:

Patient Chairs
 Operatory Lights (halogen)
 Curing & Bleaching Systems
 Imaging Products
 Scaling Products

Warranty Period:

5 year limited
 1 year
 1 year
 1 year
 1 year

Products:

Delivery Units
 Seating
 Mobile Cabinets
 Air-Driven Handpieces
 Amalgamator

Warranty Period:

5 year Limited
 1 year
 1 year
 1 year
 1 year

Extended Manufacturer Warranty (selective models):

H6000, H6005, H6025, H7005 Lubrication System 2 year
 LED Curing Lights (All Models) 2 year
 AdvanceCAM Intraoral Camera System(s) 2 year
 Radiant Operatory Lights 2 year

Limited Manufacturer Warranty (selective models):

6 month Manufacturer Warranty (selective models):
 Fiber optic systems, S333, M333, QS222, QM222, ELCA760, ELS736.

Mirage

Chair Mounted Operatory System



MP2015-LED



TP-2005 Touch Pad



TPE-2011 Touch Pad



MP2000-LED

Packing Dimensions (L x W x H)	Weight
Chair: 54 x 34 x 31	310 lbs.
Cushion: 51 x 24 x 10	27 lbs.
Unit: 51 x 21 x 18	53 lbs.
Unit: 19 x 21 x 23	36 lbs.
Dental Light: 38 x 17 x 15	28 lbs.
Cuspidor 20 x 13 x 14	18 lbs.

MP2000-LED shown
W/ Cuspidor
Optional:MO17 LCD
WIC840 Bracket

Mirage

Chair Mounted Operatory System

Description	Model	Suggested Retail Price
Mirage Operatory Package with Cuspidor	MP2000-LED	\$10,970
Mirage Operatory Package with Assistant's Instrumentation	MP2015-LED	\$10,320
Packages include the following:	(with cuspidor)	(without cuspidor)
4000 Hydraulic patient chair with wide back and full lumbar support, rotating armrests left or right, double articulating headrest with sliding height adjustment, 30 degree swivel from left and right of center, 3 programmable positions with automatic return and foot control	✓	✓
Asepsis 3 Handpiece automatic control with coolant controls, flex arm with air brake, diaphragm block design, wet/dry variable speed foot control, deluxe utility center with air /water filters and regulators, master shut off valves. Includes 3 way syringe and light post with cutout for internal wires and monitor bracket	✓	✓
L600-LED Lucent LED post mounted light with adjustable intensity, 3,000-35,000 Lux	✓	✓
2000 Porcelain cuspidor with timed bowl rinse and cup filler, telescoping 4 position assistant's package, Hve and saliva ejector, water / air quick disconnects, solids collector and clean water system	✓	
2015 Asepsis telescoping 4 position assistant's package, Hve and saliva ejector, water / air quick disconnects, solids collector and		✓
Options:		Retail
TPC3WAY-PRT Additional autoclavable 3 way syringe with tubing		\$67.00
P2330+TB Deluxe autoclavable Hve valve with tubing		\$55.00
WIC800 Standard flat screen monitor bracket		\$118.00
WIC825 Deluxe flat screen monitor bracket with 16" extension		\$360.00
WIC840 Mirage flat screen monitor bracket with 16" extension		\$190.00
MO17 17" LCD multi media flat screen monitor		\$500.00
A800N-1 Advance 800 piezo scaler – built in		\$490.00
H7000 Illumination System – ISO B (5 hole) – tubing, control box, bulb, power supply		\$278.00
H7040 Illumination handpiece tubing – 5 hole		\$108.00
H7070 Fiber optic bulb cartridge		\$50.00
H7660 Illumination System- ISO C (6 pin) – tubing, control box, power supply		\$238.00
H7045 Illumination handpiece tubing- 6 pin		\$108.00
ALED55BN-A LED 5W curing light – built in to dental unit		\$390.00
TP-2001 Touch pad control – unit head or dental chair mounted 3 preset, auto return, last position		\$358.00
53016-L Disposable Solids Collector Trap, 2 1/8' (pack of 100)		\$45.00
2000-C Mirage Cuspidor		\$650.00
TPE-2003 Touch pad Control - Chair & Electric Motor System touch pad		\$460.00
EMB-901 Built in Electric Motor System		\$1,790.00
XV100 Super thin X-ray film viewer		\$136.00
XV150-R X-ray film viewer bracket (curved) for TPC Mirage unit only		\$80.00

Mirage

Swing Mount Operatory System

Model #3550



Model #3500

MSP3500



TP-2005

Optional: Unit mounted light post LP100 & L600-LED Light Post Mounted LED Light



#L600 LED



TPE-2011



Optional: LP100 swing mount light post with optional L600-LED Operatory Light



Optional: Model #L690-LED Ceiling mounted LED operatory light

Packing Dimensions (L x W x H)	Weight
Chair: 54 x 34 x 31	320 lbs.
Cushion: 51 x 24 x 10	27 lbs.
3500: 44 x 36 x 27	103 lbs.
3550: 21 x 20 x 16	19 lbs.
LP100: 38 x 7 x 30	27 lbs.

Mirage

Swing Mount Operatory System

Description	Model	Suggested Retail Price
Mirage Swing Mount Operatory System (without light)	MSP3500	\$10,370

Packages include the following:

4000	Hydraulic patient chair with wide back and full lumbar support, rotating armrests left or right, double articulating headrest with sliding height adjustment, 30 degree swivel from left and right of center, 4 programmable positions with automatic return and foot control	✓
3500	Rotating asepsis 3 Handpiece automatic control with coolant controls, flex arm with air brake, diaphragm block design, wet/dry variable speed foot control, deluxe utility center with air /water filters and regulators, master shut off valves. Includes 3 way syringe and clean water system	✓
3550	Rear radius asepsis assistant's arm system, Hve and saliva ejector, water quick disconnect and solids collector	✓

Options:

Retail

3500	Mirage swing mount unit with chair bracket (for TPC chair only)	\$3,600.00
3550	Mirage rear swing mount suction package (for TPC chair only)	\$980.00
LP-100	Mirage swing mount light post (ordered w/unit)	\$700.00
LP-105	Mirage swing mount monitor post with monitor mounting bracket (ordered w/unit)	\$870.00
L600-LED	Lucent LED Operatory Light	\$1,280.00
L690-LED	Lucent LED Ceiling Mounted Operatory Light	\$1,840.00
L700	Advance Operatory Light	\$920.00
TPC3WAY-PR T	Additional autoclavable 3 way syringe with tubing	\$67.00
P2330+TB	Deluxe autoclavable Hve valve with tubing	\$55.00
WIC800	Standard flat screen monitor bracket	\$118.00
WIC825	Deluxe flat screen monitor bracket with 16" extension	\$360.00
WIC840	Mirage flat screen monitor bracket with 16" extension	\$190.00
MO17	17" LCD multi media flat screen monitor	\$500.00
A800N-1	Advance 800 piezo scaler – built in	\$490.00
H7000	Illumination System – ISO B (5 hole) – tubing, control box, bulb, power supply	\$278.00
H7040	Illumination handpiece tubing – 5 hole	\$108.00
H7070	Fiber optic bulb cartridge	\$50.00
H7660	Illumination System – ISO C (6 pin) – tubing, control box, power supply	\$238.00
H7045	Illumination handpiece tubing – 6 pin	\$108.00
ALED55BN-A	LED 5W curing light – built in to dental unit	\$390.00
TP-2001	Touch pad control – unit head or dental chair mounted 3 preset, auto return, last position	\$358.00
XV100	Super thin X-ray film viewer	\$136.00
XV150-R	X-ray film viewer bracket (curved) for TPC Mirage Unit only	\$80.00
TPCRDSBRKT	TPC Radius Bracket	\$320.00
53016-L	Disposable Solids Collector Trap 2 1/8" (pack of 100)	\$45.00
TPE-2003	Touch pad Control - Chair & Electric Motor System Touch pad	\$460.00
EMB-901	Built in Electric Motor System	\$1,790.00

Mirage

Patient Chair



Model #4000

Foot Control

Hands-free positioning of the patient. 2-programmable positions plus an entry/exit position and last position.



Cast aluminum base for high durability



Armrests swing-out for patient entry and exit from the chair



Re-enforced seat upholstery provides extra comfort and high durability



Articulating dual axis headrest rotation allows for optimum positioning of the oral cavity without the need to reposition the chair



Locking lever allows user to lock chair into desired position



Seat rotates 30° to left and right of center to accommodate different working styles and to maximize access to intraoral x-ray system



Safety shut-off plate disables seat down/backrest recline functions to prevent injury to the operator or damage to items beneath the plate.

Specifications:

Lifting/lowering mechanism:	Hydraulic, cantilever type
Initial height/stroke:	15.5" / 15"
Backrest reclining angle:	0° (Horizontal) – 70°
Seat tilting:	10° – 20°, synchronized with backrest
Preset position:	Microcomputer control. Three preset position, autoreturn, last position
Chair rotation angle:	30° left / 30° right of centerline
Headrest:	Dual axis type
Safety shut-off plate:	Under the main link
Emergency stop:	Any switch can cancel chair movement
Warranty	5 Year Limited

Standard Features:

- Synchronous backrest
- Articulating dual axis headrest
- Cast aluminum base
- Swing-away armrests
- Programmable foot control
- Short pump cover

Mirage

Patient Chair

Description	Model	Suggested Retail Price
Mirage Hydraulic Patient Chair	#4000	\$5,790

Product includes the following:

- Two programmable positions
- One preset exit position
- Electronic foot control with auto return function
- Built-in fuse / surge protection
- Toe guard protection to prevent scuffing
- All-metal construction
- Safety shut-off base plate
- Double articulating headrest, adjustable for height and wheelchair positioning
- Locking swivel, 60 degree
- Pivoting armrests for easy entry to and exit from chair
- Seamless Upholstery
- Wide chair back
- Coordinated leg rest tilt
- Input voltage 110V or 220V

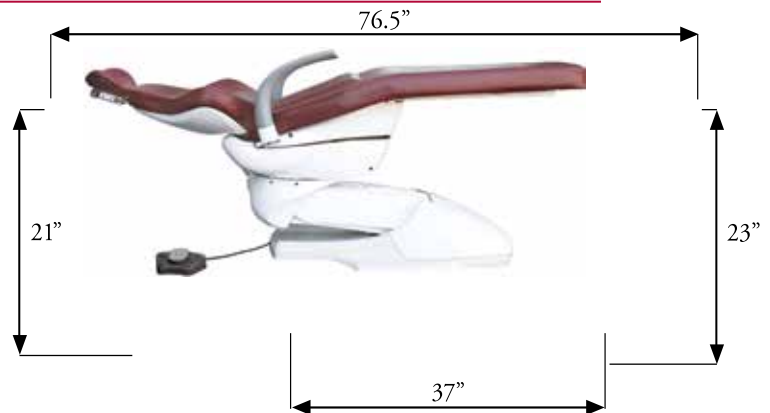

Standard: PC-1000-DU
Wide backrest



Optional: PC-2000-BC Narrow
backrest with slings.



Optional: TP-2005 Touch pad
control installed on dental chair

Packing Dimensions (L x W x H)	Weight
Chair: 54 x 34 x 31	300 lbs.
Cushion: 51 x 24 x 10	27 lbs.
Chair Bracket 22 x 9 x 6	11 lbs.

Options:

		Retail
TP-2001	Touch pad control – unit head or dental chair mounted, 3 preset, auto return, last position	\$ 358.00
TPCBRKT	TPC post mount chair bracket	\$ 270.00
PC-1000-DU	Replacement Dental Chair Upholstery Duration Vinyl -Wide Back	\$600.00
PC-1000-Vinyl-UC	Upcharge Non-Standard Dental Chair Upholstery Vinyl -Wide Back	\$450.00
PC-1000-Ultr-UC	Upcharge Ultra leather Dental Chair Upholstery leather -Wide Back	\$700.00
PC-1000-PR-UC	Upcharge Nauga Soft Dental Chair Upholstery Vinly -Wide Back (PR50, 49, 47, 40, 37)	\$200.00
PC-2000-DU	Replacement Dental Chair Upholstery Duration Vinyl -Narrow Back	\$740.00
PC-2000-Vinyl-UC	Upcharge Non-Standard Dental Chair Upholstery Vinly -Narrow Back	\$550.00
PC-2000-ultr-UC	Upcharge Ultra Leather Dental Chair Upholstery leather -Narrow Back	\$800.00
PC-2000-PR-UC	Upcharge Nauga Soft Dental Chair Upholstery Vinly -Narrow Back (PR50, 49, 47, 40, 37)	\$300.00

* Specify color and product code when ordering *

Mirage

Orthodontic Hydraulic Patient Chair



Foot Control

Hands-free positioning of the patient. 2-programmable positions plus an entry/exit position and last position.



Cast aluminum base for high durability



Articulating dual axis headrest rotation allows for optimum positioning of the oral cavity without the need to reposition the chair



Optional armrests swing-out for patient entry and exit from the chair



Locking lever allows user to lock chair into desired position



Seat rotates 30° to left and right of center to accommodate different working styles and to maximize access to intraoral x-ray system



Safety shut-off plate disables seat down/backrest recline functions to prevent injury to the operator or damage to items beneath the plate.

Specifications:

Lifting/lowering mechanism:	Hydraulic, cantilever type
Initial height/stroke:	15.5" / 15"
Backrest reclining angle:	0° (Horizontal) – 70°
Seat tilting:	10° – 20°, synchronized with backrest
Preset position:	Microcomputer control. Three preset position, autoreturn, last position
Chair rotation angle:	30° left / 30° right of centerline
Headrest:	Dual axis type
Safety shut-off plate:	Under the main link
Emergency stop:	Any switch can cancel chair movement
Warranty	5 Year Limited

Standard Features:

- Synchronous backrest
- Articulating dual axis headrest
- Cast aluminum base
- Programmable foot control
- Short pump cover

Mirage

Orthodontic Hydraulic Patient Chair

Description

Model

Suggested Retail Price

Mirage Orthodontic Hydraulic Patient Chair

#3000

\$5,590

Packages include the following:

- Two programmable positions
- One preset exit position
- Electronic foot control with auto return function
- Built-in fuse / surge protection
- Toe guard protection to prevent scuffing
- All-metal construction
- Safety shut-off base plate
- Double articulating headrest, adjustable for height and wheelchair positioning
- Locking swivel, 60 degree
- Seamless Upholstery
- Coordinated leg rest tilt
- Input voltage 110V or 220V



Optional: TP-2005 Touchpad control installed on dental chair

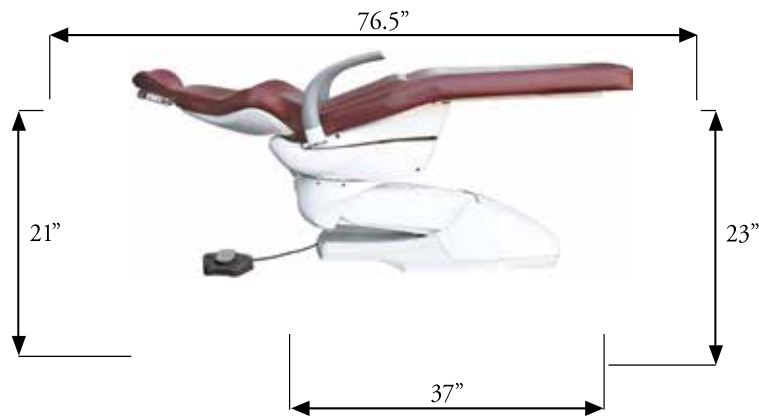

Options:

Retail

TP-2001	Touch pad control – unit head or dental chair mounted, 3 preset, auto return, last position	\$ 358.00
TPCBRKT	TPC Post mount chair bracket	\$ 270.00
PC-1000-DU	Replacement Dental Chair Upholstery-Wide Back Duration Vinyl- Specify Color and Product Code	\$600.00
PC-1000-Vinyl-UC	Upcharge Non-Standard Dental Chair Upholstery-Wide Back Vinyl- Specify Color and Product Code	\$450.00
PC-1000-ULTR-UC	Upcharge Ultra leather Dental Chair Upholstery-Wide Back Ultra leather- Specify Color and Product Code	\$700.00
PC-1000-PR-UC	Upcharge Nauga Soft Dental Chair Upholstery-Wide Back Nauga Soft- Specify Color and Product Code (PR50, 49, 47, 40, 37)	\$200.00
M4000-09	Magnetic Pillow Headrest	\$390.00

Packing Dimensions (L x W x H)	Weight
Chair: 54 x 34 x 31	300 lbs.
Cushion: 51 x 24 x 10	27 lbs.

Mirage

Orthodontic Package

Standard Features:

- Synchronous backrest
- Articulating dual axis headrest
- Cast aluminum base
- Programmable foot control
- Short pump cover
- Hydraulic pump for quiet operation

Standard Features:

- Color temperature: 4500° K
- Halogen lamp 12 Volts, 55 Watts
- Bulb type: H3
- Light intensity (Lux):
High 24,000;
Low 12,000
- Focal length: 27" (70 cm)
- Illumination area: 3" x 7"

Standard Control Features:

- 3 HP Automatic selection
- 3-way Syringe
- Vacuum Package with Saliva Ejector and HVE
- Self contained water bottle system
- Variable speed disc-type foot control
- Water coolant on/off switch with flow control
- 1 Year warranty



Optional:
OMC-2200
LCD Bracket

MOP3000

Optional: Magnetic
headrest

Counter top
dimensions

Rear cabinet
door view

Pull out writing
surface

Packing Dimensions (L x W x H)	Weight
Chair: 54 x 34 x 31	300 lbs.
Cushion: 51 x 24 x 10	27 lbs.
Light 26 x 14 x 8	21 lbs.
Cabinet 28 x 26 x 37	155 lbs.

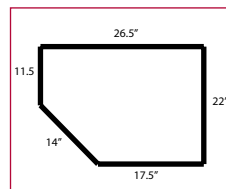

Mirage

Orthodontic Package

Description	Model	Suggested Retail Price
Mirage Orthodontic Package	MOP3000	\$9,050

Packages include the following:

3000 Hydraulic patient chair with wide back and full lumbar support, double articulating headrest with sliding height adjustment, 30 degree swivel from left and right of center, 4 programmable positions with automatic return and foot control ✓

2375 This orthodontic mobile delivery cabinet offers a pullout writing surface, two instrument drawers, one medium and two large storage drawers for materials and supplies that fully extend and quickly remove for easy cleaning. In addition, these cabinets provide a large open space for accessories with convenient access from the front. Oversized locking dual-caster wheel ✓

L700 Advance post mounted light with dual intensity, 4200-4500 Kelvin, dual axis light head rotation ✓

TPCBRKT The chair bracket is included at no charge (value: \$270) when purchasing the Mirage Orthodontic Package ✓

Options:

		Retail
WIC840	Mirage flat screen monitor bracket with 16" extension	\$190.00
MO17	17" LCD multi media flat screen monitor	\$500.00
H7000	Illumination System – ISO B (5 hole) – tubing, control box, bulb, power supply	\$278.00
H7660	Illumination System – ISO C (6 pin) – tubing, control box, power supply	\$238.00
ALED55BN-A	LED 5W curing light – built in to dental unit	\$390.00
TP-2001	Touch pad control – unit head or dental chair mounted 3 preset, auto return, last position	\$358.00
OMC2200	LCD monitor bracket	\$300.00
53016-L-100	Disposable Solids Collector Trap 2 1/8" (Pack of 100)	\$45.00
OMC-ST81	Optional Stone Surface on OMC 2375, Color Artic	\$350.00
OMC-ST82	Optional Stone Surface on OMC 2375, Color White	\$350.00
OMC-ST85	Optional Stone Surface on OMC 2375, Color Cream	\$350.00
OMC-ST86	Optional Stone Surface on OMC 2375, Color Bamboo	\$350.00
M4000-09	Optional Magnetic Headrest	\$390.00

Optional: Stone Counter top
OMC-ST81



Optional: Stone Counter top
OMC-ST82



Optional: Stone Counter top
OMC-ST85



Optional: Stone Counter top
OMC-ST86



Laguna

Electromechanical Patient Chair



Foot Control
Hands-free positioning of the patient. 2-programmable positions plus an entry/exit position.



Reinforced seat upholstery provides extra comfort and durability



Articulating dual axis headrest rotation allows for optimum positioning of the oral cavity without the need to reposition the chair



Optional armrests pivot up and down for patient entry and exit from the chair



Solid steel base

Specifications:

Lifting/lowering mechanism:	Electromechanical, cantilever type
Initial height/stroke:	15.5" / 15"
Backrest reclining angle:	0° (Horizontal) – 70°
Seat tilting:	10° – 20°, synchronized with backrest
Preset position:	Microcomputer control. Three preset position, auto return, last position
Chair rotation angle:	Fixed
Headrest:	Dual axis type
Safety shut-off plate:	Under the main backrest link
Emergency stop:	Any switch can cancel chair movement
Warranty	5 Year Limited

Standard Features:

- Independent backrest
- Articulating dual axis headrest
- Solid Steel base
- Programmable foot control
- Short pump cover

Laguna

Electromechanical Patient Chair

Description	Model	Suggested Retail Price
Laguna Electromechanical Patient Chair	#L2000	\$3,590

Packages include the following:

- Two programmable positions
- One preset exit position
- Electronic foot control with auto return function
- Built-in fuse / surge protection
- Toe guard protection to prevent scuffing
- All-metal construction
- Double articulating headrest, adjustable for height and wheelchair positioning
- Seamless Upholstery
- Input voltage 110V or 220V



Optional: TP-2007 Touch pad control installed on dental chair

Packing Dimensions (L x W x H)	Weight
Chair: 54 x 34 x 32	300 lbs.
Cushion: 51 x 9 x 23	27 lbs.



Options:

		Retail
TP-2001	Touch pad control – chair mounted, 3 preset, auto return, last position	\$ 358.00
PC-5000-DU	Upcharge Dental Chair Upholstery-Wide Back Duration Vinyl- Specify Color and Product Code	\$600.00
PC-5000-Vinyl-UC	Upcharge Non-Standard Dental Chair Upholstery-Wide Back Vinyl- Specify Color and Product Code	\$450.00
PC-5000-ULTR-UC	Upcharge Ultra leather Dental Chair Upholstery-Wide Back Ultra leather- Specify Color and Product Code	\$700.00
PC-5000-PR-UC	Upcharge Nauga Soft Dental Chair Upholstery-Wide Back Nauga Soft- Specify Color and Product Code	\$450.00
LAGBRKT	Laguna Post mount chair bracket	\$ 270.00

Laguna

Chair Mounted Operatory System

LP-2100-600LED



Packing Dimensions (L x W x H)	Weight
Chair: 54 x 34 x 31	310 lbs.
Cushion: 51 x 24 x 10	27 lbs.
Unit: 51 x 21 x 18	53 lbs.
Unit: 19 x 21 x 23	36 lbs.
Dental Light: 38 x 17 x 15	28 lbs.
Cuspidor 20 x 13 x 14	18 lbs.

Laguna

Chair Mounted Operatory System

Description	Model	Suggested Retail Price
Laguna Operatory Package with Cuspidor	LP2100-600LED	\$8,770
Laguna Operatory Package with Assistant's Instrumentation		\$8,120
Packages include the following:	(with cuspidor)	(without cuspidor)
L2000 Electromechanical patient chair with wide back and full lumbar support, rotating armrests left or right, double articulating headrest with sliding height adjustment, 30 degree swivel from left and right of center, 3 programmable positions with automatic return and foot control	✓	✓
Asepsis 3 Handpiece automatic control with coolant controls, flex arm with air brake, diaphragm block design, wet/dry variable speed foot control, deluxe utility center with air /water filters and regulators, master shut off valves. Includes 3 way syringe and light post with cutout for internal wires and monitor bracket	✓	✓
L600-LED Lucent LED post mounted light with adjustable intensity, 3,000-35,000 Lux	✓	✓
2000 Porcelain cuspidor with timed bowl rinse and cup filler, telescoping 4 position assistant's package, Hve and saliva ejector, water / air quick disconnects, solids collector and clean water system	✓	
2015 Asepsis telescoping 4 position assistant's package, Hve and saliva ejector, water / air quick disconnects, solids collector and		✓
Options:		Retail
TPC3WAY-PRT Additional autoclavable 3 way syringe with tubing		\$67.00
P2330+TB Deluxe autoclavable Hve valve with tubing		\$55.00
WIC800 Standard flat screen monitor bracket		\$118.00
WIC825 Deluxe flat screen monitor bracket with 16" extension		\$360.00
WIC840 Mirage flat screen monitor bracket with 16" extension		\$190.00
MO17 17" LCD multi media flat screen monitor		\$500.00
A800N-1 Advance 800 piezo scaler – built in		\$490.00
H7000 Illumination System – ISO B (5 hole) – tubing, control box, bulb, power supply		\$278.00
H7040 Illumination handpiece tubing – 5 hole		\$108.00
H7070 Fiber optic bulb cartridge		\$50.00
H7660 Illumination System- ISO C (6 pin) – tubing, control box, power supply		\$238.00
H7045 Illumination handpiece tubing- 6 pin		\$108.00
ALED55BN-A LED 5W curing light – built in to dental unit		\$390.00
TP-2001 Touch pad control – unit head or dental chair mounted 3 preset, auto return, last position		\$358.00
53016-L Disposable Solids Collector Trap, 2 1/8' (pack of 100)		\$45.00
2000-C Mirage Cuspidor		\$650.00
TPE-2003 Touch pad Control - Chair & Electric Motor System touch pad		\$460.00
EMB-901 Built in Electric Motor System		\$1,790.00
XV100 Super thin X-ray film viewer		\$136.00
XV150-R X-ray film viewer bracket (curved) for TPC Mirage unit only		\$80.00

Laguna

Orthodontic Package

Standard Features:

- Independent backrest
- Articulating dual axis headrest
- Steel base
- Armrests pivot up and down
- Programmable foot control
- Short pump cover
- Electric motor operated

Standard Features:

- Color temperature: 4500° K
- Halogen lamp 12 Volts, 55 Watts
- Bulb type: H3
- Light intensity (Lux):
High 24,000;
Low 12,000
- Focal length: 27" (70 cm)
- Illumination area: 3" x 7"

Standard Control Features:

- 3 HP Automatic selection
- 3-way Syringe
- Vacuum Package with Saliva Ejector and HVE
- Self contained water bottle system
- wet / dry foot control
- 1 Year warranty



LOP2000

Standard Cabinet Features:

- Five easy to remove and clean full extension drawers, and one pull-out writing surface.
- High quality hardware throughout
- Oversized caster wheels
- Four stationary handles for easy cart positioning
- A removable counter - top plastic tray
- Standard 12" X 12" Junction Box
- 5' Length of umbilical

Packing Dimensions (L x W x H)	Weight
Chair: 54 x 34 x 32	300 lbs.
Cushion: 52 x 24 x 10	27 lbs.
Light 26 x 14 x 8	21 lbs.
Cabinet 26 x 28 x 37	155 lbs.

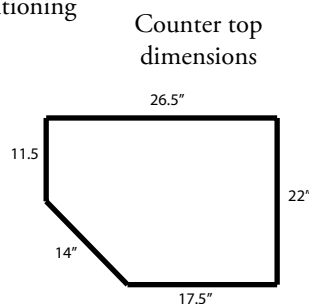

Rear cabinet door view



Pull out writing surface



Laguna

Orthodontic Package

Description	Model	Suggested Retail Price
Laguna Orthodontic Package	LOP2000	\$7,170

Packages include the following:

L2000 Electromechanical patient chair with wide back and full lumbar support, double articulating headrest with sliding height adjustment, 3 programmable positions with automatic return and foot control ✓

2375 This orthodontic mobile delivery cabinet offers a pullout writing surface, two instrument drawers, one medium and two large storage drawers for materials and supplies that fully extend and quickly remove for easy cleaning. In addition, these cabinets provide a large open space for accessories with convenient access from the front. Oversized locking dual-casters. ✓

L700 Advance post mounted light with dual intensity, 4200-4500 Kelvin, dual axis light head rotation ✓

LAGBRKT The chair bracket is included at no charge (value: \$270) when purchasing the Laguna Orthodontic Package ✓

Options:

		Retail
WIC840	Mirage flat screen monitor bracket with 16" extension	\$190.00
M017	17" LCD multi media flat screen monitor	\$500.00
H7000	Illumination System – ISO B (5 hole) – tubing, control box, bulb, power supply	\$278.00
H7660	Illumination System – ISO C (6 pin) – tubing, control box, power supply	\$238.00
ALED55BN-1	LED 5W curing light – built in to dental unit	\$390.00
TP-2001	Touch pad control – chair mounted, 3 preset, auto return	\$358.00
OMC2200	LCD monitor bracket	\$300.00
53016-L-100	Disposable Solids Collector Trap 2 1/8" (pack of 100)	\$45.00
OMC-ST81	Optional Stone Surface on OMC 2375, Color Artic	\$350.00
OMC-ST82	Optional Stone Surface on OMC 2375, Color White	\$350.00
OMC-ST85	Optional Stone Surface on OMC 2375, Color Cream	\$350.00
OMC-ST86	Optional Stone Surface on OMC 2375, Color Bamboo	\$350.00
LAGBRKT	Laguna Post mount chair bracket	\$270.00

Optional: Stone Counter top
OMC-ST81



Optional: Stone Counter top
OMC-ST82



Optional: Stone Counter top
OMC-ST85



Optional: Stone Counter top
OMC-ST86



Mirage

Chair Mounted Delivery System



Standard Features

- Asepsis automatic control for three handpieces
- Individual handpiece pressure adjustments
- Non-retracting water coolant with on/off
- Individual water coolant flow controls
- Air coolant flow control
- Handpiece tubing flush system
- Ultra soft handpiece tubing
- 4-hole straight gray asepsis tubing with Midwest connector
- Stainless steel tray with non-skid pad
- Disc foot control wet/dry toggle with 7' of smooth tubing
- Equipment utility center with asepsis housing
- Vacuum canister with solids collector screen
- Water outlet quick disconnect
- Air outlet quick disconnect for prophylaxis jet
- Self contained water system with city/bottle selector switch
- Straight light post for unit mount dental light
- Pre-wiring for fiber optic light source
- Air-actuated counterbalanced arm lock
- 3 way syringe on unit head

Gravity Drain Cuspidor

- Contoured bowl is made of fine porcelain for easy cleaning and infection control.
- The cuspidor operates with adjustable timed bowl rinse and cup filler
- Swing away cuspidor bowl with safety breakaway feature
- Electric solenoid controlled

Assistant's Instrumentation on Telescoping Arm

- 1 autoclavable HVE with asepsis tubing
- 1 autoclavable saliva ejector with asepsis tubing



Model 2000



TP-2005



TPE-2011

Options

- Built In Electric Handpiece
- Super thin X-ray viewer to mount on unit control head
- Built-in Led curing light
- Built-in scaler
- Illumination light source
- Post-mounted utility tray
- 17" LCD Monitor
- LCD monitor bracket



Control Head: Easy to read pressure gauge. Easy access controls for simple adjustments. Ultra soft handpiece tubing minimizing hand and wrist stress.



Cuspidor Bowl: The deep contoured bowl is made of fine porcelain for easy cleaning and infection control.



Optional: Multi media flat screen monitor for chair side intraoral imaging, patient education and DVD viewing.



Built in self contained water bottle system including city/bottle selector switch.



Optional: Super thin xray viewer mounted to unit head.



Built in air and water quick disconnect for ultrasonic scaling and prophylaxis jet

Mirage

Chair Mounted Delivery System

Model #2015

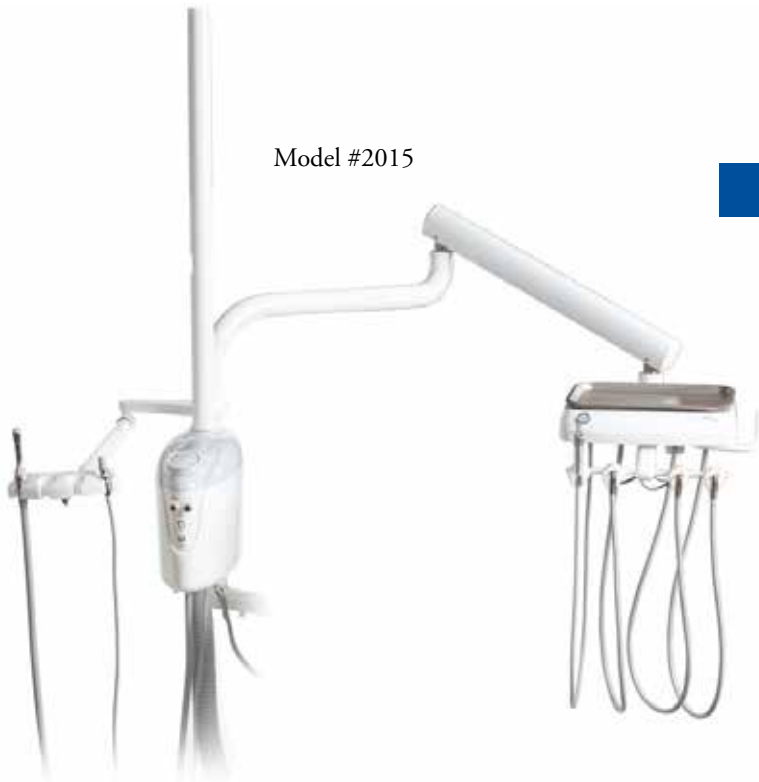

Optional: TP-2005
Touchpad control



Optional: TPE-2011
Touchpad control

Packing Dimensions (L x W x H)	Weight
Unit: 51 x 21 x 17	55 lbs.
Unit: 19 x 21 x 23	36 lbs.
Cuspidor: 13 x 14 x 21	18 lbs.

Description

Mirage Chair Mounted Delivery System with Cuspidor
Mirage Chair Mounted Delivery System

Package includes the following:

Asepsis 3 handpiece automatic control with coolant controls, flex arm with air brake, diaphragm block design, wet/dry variable speed foot control, deluxe utility center with air /water filters and regulators, master shut off valves. Includes 3 way syringe and light post with cutout for internal wires and monitor bracket, 5' umbilical

Porcelain cuspidor with timed bowl rinse and cup filler, telescoping 4 position assistant's package, Hve and saliva ejector, water / air quick disconnects, solids collector and clean water system

Asepsis telescoping 4 position assistant's package, Hve and saliva ejector, water/air quick disconnect, solids collector and clean water system

Light Post

Model

Suggested Retail Price

	2000	2015
	(with cuspidor)	(without cuspidor)
Mirage Chair Mounted Delivery System with Cuspidor		\$3,900
Mirage Chair Mounted Delivery System		\$3,250
Asepsis 3 handpiece automatic control with coolant controls, flex arm with air brake, diaphragm block design, wet/dry variable speed foot control, deluxe utility center with air /water filters and regulators, master shut off valves. Includes 3 way syringe and light post with cutout for internal wires and monitor bracket, 5' umbilical	✓	✓
Porcelain cuspidor with timed bowl rinse and cup filler, telescoping 4 position assistant's package, Hve and saliva ejector, water / air quick disconnects, solids collector and clean water system	✓	
Asepsis telescoping 4 position assistant's package, Hve and saliva ejector, water/air quick disconnect, solids collector and clean water system		✓
Light Post	✓	✓

Options:

	Retail
TPC3WAY-PRT Additional autoclavable 3 way syringe with tubing	\$67.00
P2330+TB Deluxe autoclavable Hve valve with tubing	\$55.00
WIC800 Standard flat screen monitor bracket	\$118.00
WIC825 Deluxe flat screen monitor bracket with 16" extension	\$360.00
WIC840 Mirage flat screen monitor bracket with 16" extension	\$190.00
M017 17" LCD multi media flat screen monitor	\$500.00
A800N-1 Advance 800 piezo scaler – built in	\$490.00
H7000 Illumination System – ISO B (5 hole) – tubing, control box, bulb, power supply	\$278.00
H7660 Illumination System – ISO C (6 pin) – tubing, control box, power supply	\$238.00
ALED55BN-A LED 5W curing light – built in	\$390.00
L600-LED Lucent LED Operatory Light	\$1,280.00
L625-LED Lucent LED Operatory Light with motion sensor	\$1,430.00
BELBRKT Belmont chair mount bracket (Bel 20/Bel 50)	\$165.00
TPCBRKT TPC chair mount bracket	\$270.00
TP-2001 Touch pad control – unit head or dental chair mounted, 3 preset, auto return, last position	\$358.00
TPE-2003 Touch pad Control - Chari & Electric Motor System touch pad	\$460.00
53016 -L-100 Disposable Solids Collector Trap, 2 1/8" (pack of 100)	\$45.00
2000-C Mirage Cuspidor	\$650.00
EMB-901 Built In Electric Motor system	\$1,790.00
XV100 Super Thin X-ray Viewer	\$136.00
XV150-R Xray viewer bracket (round cut-out) – mount to Mirage unit head (Round Arm)	\$80.00

Mirage

Mobile Cart



Model #MC-501



Model #MC-500

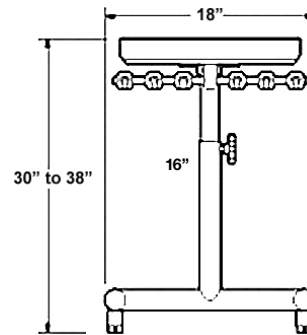

Description	Model	Suggested Retail Price
-------------	-------	------------------------

Mirage Mobile Cart	MC-500	\$2,100
Mirage Mobile Cart with Vacuum Package	MC-501	\$2,300
Asepsis 3 handpiece automatic selection with bottle system	✓	✓
3 way syringe with quick change autoclavable tip	✓	✓
Master on/off toggle	✓	✓
Air / Water pressure adjustment for each handpiece	✓	✓
Pressure gauge	✓	✓
Non-retracting water / air coolant adjustment and purge	✓	✓
Asepsis handpiece tubing	✓	✓
Painted U-frame with height adjustment, 30" to 38"	✓	✓
Vacuum canister with removable screen, water quick disconnect		✓
1 autoclavable Hve and saliva ejector and tubing		✓
Variable speed foot control	✓	✓
5 feet of umbilical	✓	✓

Options:

		Retail
H7660	Illumination system – ISO C (6 pin) – tubing, control box, power supply	\$238.00
H7000	Illumination system – ISO B (5 hole) – tubing, control box, bulb, power supply	\$278.00
A800N-1	Advance 800 N piezo scaler – built in	\$490.00
53106-L-100	Disposable Solids Collector Trap, 2 1/8" Pk of 100	\$45.00
MC500-UMB-FT	Additional Umbilical Per Foot	\$32.00
MC501-UMB-FT	Additional Umbilical Per Foot	\$35.50

Model #MC-501

Model #MC-500

Packing Dimensions: 24" x 24" x 36" / 52 lbs

Packing Dimensions: 24" x 24" x 36" / 50 lbs



Mirage

Wall / Cabinet Mounted System



Model #MS-3000

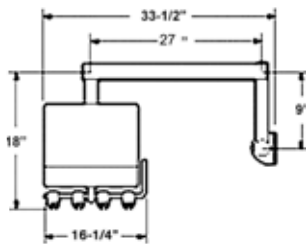

Model #MR-4000

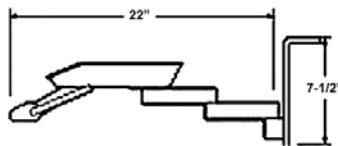

Model #MVP-5000

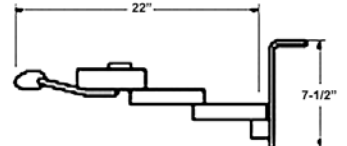

Suggested Retail Price

	MS-3000	MR-4000	MVP-5000	
Mirage Cabinet Mounted Side Delivery Unit				\$2,590
Mirage Cabinet Mounted Rear Delivery Unit				\$1,650
Mirage Cabinet Mounted Vacuum Package				\$760

Asepsis 3 handpiece automatic selection with bottle system	✓	✓	
3 way syringe with quick change autoclavable tip	✓	✓	
Master on/off toggle	✓	✓	
Air / Water pressure adjustment for each handpiece	✓	✓	
Pressure gauge	✓	✓	
Non-retracting water / air coolant adjustment and purge	✓	✓	
Asepsis handpiece tubing	✓	✓	(39" reach, 19" vertical)
Asepsis flex arm system, w/ 9" rigid arm, pneumatic brake	✓		
2" diameter wall bracket	✓		(22" reach)
Pivoting arm mounted vacuum canister w/ screen			✓
3 way syringe with quick change autoclavable tip			✓
Water quick disconnect			✓
Vacuum canister with removable screen			✓
4 position holder, 1 autoclavable Hve and saliva ejector & tubing			✓
Variable speed foot control	✓	✓	

Options:

		Retail
H7660	Illumination system – ISO C (6 pin) – tubing, control box	\$238.00
H7000	Illumination system – ISO B (5 hole) – tubing, control box, bulb	\$278.00
A800N	Advance 800 piezo scaler – built in	\$490.00
P2330+TB	Deluxe autoclavable Hve valve with tubing	\$55.00
53106-L-100	Disposable Solids Collector Trap, 2 1/8" (Pack of 100)	\$45.00

Packing Dimensions: 17" x 21" x 51" / 48 lbs
MS-3000

Packing Dimensions: 22" x 20" x 15" / 22 lbs
MR-4000

Packing Dimensions: 13" x 13" x 8" / 10 lbs
MVP-5000

Mirage

Panel & Cabinet Mount Systems



Model #MP-2600
Mirage Panel Mount
Rear Delivery System



Model #MP-2601
Mirage wall / Cabinet Mount
Rear Assistants package



Model #MR-4500
Mirage Rear Cabinet Mount
Delivery System with Assistants Package



Standard Features

- 2 Handpiece Tubing Positions
- 3 Position HP Holder
- TPC Press ring style syringe
- Individual drive air & water coolant controls
- Foot control
- Control Dimensions 8 1/2" x 1 3/4" x 5"
- Cut-out dimensions 7 1/2" x 11 1/2"
- Syringe has adjustable air & water controls
- Air / Water master control W/ Regulator.

Standard Features

- 2 HVE Suction Valves
- 1 SE Suction Valve
- 3 Position Suction Holder
- Vacuum canister with removable screen

Standard Features

- Asepsis 3 handpiece automatic selection with bottle system
- 3 way syringe with quick change autoclavable tip
- Master on/off toggle
- Air / Water pressure adjustment for each handpiece
- Pressure gauge
- Non-retracting water / air coolant adjustment and purge
- Asepsis handpiece tubing
- Asepsis flex arm system, w/ 9" rigid arm, pneumatic brake
- Self contained bottle system
- Stainless Steel tray
- 3 way syringe with quick change autoclavable tip
- Utility center
- Vacuum canister with removable screen

Description

Model

Suggested Retail Price

Mirage Panel Mount Rear Delivery System (2 HP manual select, 3-Way Syringe, 3 position HP holder, Utility Valves)	MP-2600	\$770.00
Mirage Wall & Cabinet Mount Assistance Package (2 HVE, 1 SE, 3 position holder)	MP-2601	\$270.00
Mirage Rear Cabinet Mounted Delivery System W/ Assistants Package	MR-4500	\$2,250.00

Options:

Retail

H7660	Illumination system – ISO C (6 pin) – tubing, control box	\$238.00
H7000	Illumination system – ISO B (5 hole) – tubing, control box, bulb	\$278.00
A800N	Advance 800 piezo scaler – built in	\$490.00
P2330+TB	Deluxe autoclavable Hve valve with tubing	\$55.00
53106-S-100	Disposable Solids Collector Trap, 1 7/8" (Pack of 100)	\$45.00
53106-L-100	Disposable Solids Collector Trap, 2 1/8" (Pack of 100)	\$45.00

Packing Dimensions: 8" x 17" x 15" / 9 lbs
MP-2600

Packing Dimensions: 8" x 17" x 15" / 5 lbs
MP-2601

Packing Dimensions: 20" x 20" x 15" / 27 lbs
MP-4500

OMC 2375

Orthodontic Mobile Delivery Cabinet



Optional OMC 2200
Monitor Bracket



Rear compartment

4" W
X
12" D
X
20" H



Writing surface with
optional solid surface

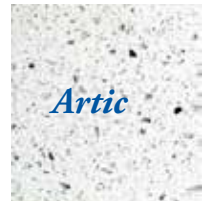

Artic

OMC-ST81



White

OMC-ST82



Cream

OMC-ST85



Bamboo

OMC-ST86

Optional hard surface stone top

Function:

This orthodontic mobile delivery cabinet offers a pullout breadboard, two instrument drawers, one medium and two large storage drawers for materials and supplies that fully extend and quickly remove for easy cleaning. In addition, these cabinets provide a large open space for accessories with convenient access from the front. The oversized dual-caster wheels, makes positioning of the cabinet simple and easy on all floor surfaces, including carpet.

Standard Cabinet Features:

- Five easy to remove and clean full extension drawers, and one pull-out writing surface.
- High quality hardware throughout
- Oversized caster wheels
- Four stationary handles for easy cart positioning
- A removable counter - top plastic tray
- Standard 12" X 12" Junction Box
- 5' Length of umbilical

Standard Control Features:

- 3 HP Automatic selection
- 3-way Syringe
- Vacuum Package with Saliva Ejector and HVE
- Self contained water bottle system
- Variable speed disc-type foot control
- Water coolant on/off switch with flow control
- 1 Year warranty

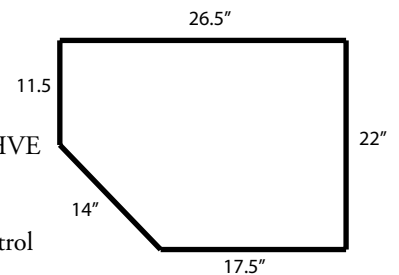

Description

Model

Suggested Retail Price

Orthodontic Mobile Delivery Cabinet

OMC2375

\$2,390

Options:

Retail

A800N-1	Advance 800N Piezo Scaler - Built in	\$490.00
ALED55BN-A	LED 55BN 5W LED Curing Light -Built in	\$390.00
2375-UMB-FT	Umbilical Per Foot	\$32.00
OMC2200	LCD Monitor Bracket W/ Post	\$300.00
OMC-ST81	Optional Stone Surface on OMC 2375, Color Artic	\$350.00
OMC-ST82	Optional Stone Surface on OMC 2375, Color White	\$350.00
OMC-ST85	Optional Stone Surface on OMC 2375, Color Cream	\$350.00
OMC-ST86	Optional Stone Surface on OMC 2375, Color Bamboo	\$350.00
53016-L-100	Disposable Solids Collector Trap 2 1/8" (Pack of 100)	\$45.00

Packing Dimensions: 26" x 28" x 37" / 155 lbs

PC 2700

Portable Dental Chair Package



Description

Model

Suggested Retail Price

Portable Dental Chair Package

PC 2700

\$1,730

(Includes patient Chair, Light, Stool, Tray, Spittoon & heavy duty Carry bags)

Options Model

Suggested Retail Price

PC 2720	Portable Patient Chair	\$650.00
PC 2740	Portable Dr. Stool	\$390.00
PC 2760	Portable Operator Light	\$390.00
PC 2780	Stainless Steel tray and spit cup	\$150.00
PC 2790	Portable chair heavy duty carry bag	\$180.00
PC 2795	Stool heavy duty carry bag	\$160.00

Shipping Dimensions:

Packing Dimensions: 17" x 22" x 30" / 78 lbs

PC 2630

Portable Delivery System

- PC2930: Includes
- LED Curing light
 - Piezo Scaler



The **PC2630** is a fully self contained air dental system. Quick and easy to setup and operate. Ready for travel. Tornado HP available upon request. Ask for details.

Description	Model	Suggested Retail Price
-------------	-------	------------------------

Portable Dental System	PC2630	\$1,950
Portable Dental System W/ Scaler & LED Curing Light	PC2930	\$2,950

Package Includes the following

• 4 hole or 2 hole instrument tubings (specify)	✓	✓
• 3 way syringe	✓	✓
• Saliva ejector	✓	✓
• Self contained water bottle system	✓	✓
• Self contained oil - less ompressor (580W / 7L)	✓	✓
• Foot control	✓	✓
• Air venturi vacuum system	✓	✓
• Transportation case with pull out handle.	✓	✓
• 1 year warranty	✓	✓
• Built In Scaler		✓
• Built In Curing Light		✓

Options:	Retail
A800N-1 Advance 800 piezo scaler – built in "Factory Installed"	\$540.00
53012-INSTL Female Quick disconnect (factory installed)	\$110.00

Shipping Dimensions: pc2630

Packing Dimensions: 16" x 20" x 27" / 56 lbs

Shipping Dimensions: pc2930

Packing Dimensions: 16" x 20" x 27" / 60 lbs

PC 2635

Portable Delivery System



The **PC2635** is a portable, self contained delivery system suitable for use in-office, nursing homes, hospitals, or wherever any off-site dentistry is required. The PC2635 is a lightweight, portable system that is easily transported. Air and water supply are included on the PC2635 portable dental system. Optional Tornado High and Slow speed handpieces are available.

Description

Portable Dental System

Model

PC2635

Suggested Retail Price

\$1,425

Package Includes the following

- 4 hole or 2 hole instrument tubings (specify)
- 3 way syringe
- Self contained oil - less compressor (580W / 7L)
- Foot control
- Automatic Handpiece flush System
- Built in carrying handle
- Self contained water bottle system
- 1 year warranty



Shipping Dimensions:

Packing Dimensions: 23" x 15" x 22" / 66 lbs

PC 2530

Mobile Vacuum System



- Moves with Ease
- Efficient
- Simple Maintenance
- Perfect Backup
- Cost Effective
- Compact



Specifications

Electrical: 7/8 Horsepower
 115 VAC, 50/60 Hz
 230 VAC, 50/60 Hz
 4.0 Amps

Sound: 70 db

Motor: Variable speed control

Construction: Impact resistant molded polyethylene

Vacuum: 80" of water (6" of Hg)

Airflow: 75 cfm

Canister: 2 Liter

Dimensions: 14" L x 12" W x 31" H

Shipping: Via FedEx / UPS

The PC 2530 Mobile Vac System is a portable, self contained vacuum system suitable for use by the dentist in a temporary location or when it is not feasible to install a central vacuum system.

Description	Model	Suggested Retail Price
Mobile Vacuum System	PC2530	\$1,390

Package Includes the following

- HVE and SE Valves ✓
- Drain Line ✓
- 2 SE suction tips ✓
- Power cord ✓
- Solids filter ✓
- 1 year warranty ✓

Shipping Dimensions:

Packing Dimensions: 18" x 17" x 33" / 71 lbs

Mirage

Operatory Stools

Model SS-5105



Dimensions:

vertical adjustment range: 0" – 3.5"
 Seat width: 13" x 14"
 Seat height ranges: 23" – 31"
 5-Leg base diameter: 24"
 Shipping dimensions: 22" x 21" x 15" / 23 lbs.

Model DR-1102



Dimensions:

Backrest vertical adjustment range: 0" – 3.25"
 Seat width: 18"
 Seat height ranges: 19" – 23"
 5-Leg base diameter: 24"
 Shipping dimensions: 24" x 23" x 16" / 34 lbs.

Model DR-5109



Dimensions:

Backrest vertical adjustment range: 0" – 3.25"
 Seat width: 15 3/4"
 Seat height ranges: 19" – 23"
 5-Leg base diameter: 24"
 Shipping dimensions: 23" x 22" x 16" / 38 lbs.

Description

	Model	Suggested Retail Price
Mirage saddle stool	SS-5105	\$490
Mirage doctor's stool	DR-1102	\$460
Mirage doctor's stool with armrests	DR-5109	\$600

Stool Package includes the following:

Five-leg, ultra stable base, 24" diameter	✓	✓	✓
Gas cylinder lift for seat height adjustment	✓	✓	✓
Adjustable for right or left hand use	✓	✓	✓
Large, firm cushion seat	✓	✓	✓
Adjustable full ring foot rest	✓		
Dual wheel casters	✓	✓	
Adjustable anatomical body support bar	✓		
Height adjustment	23" - 31"	19" - 23"	19" - 23"
16 Upholstery color choices	✓	✓	✓
Seat tilt	✓	✓	
Adjustable armrest			✓
1 year warranty	✓	✓	✓

Options *Specify Color And Product Code*

DR1102-9	Replacement DR1102 Seat Cushion ONLY Duration Vinyl	\$140.00
DR1102-11	Replacement DR1102 Chair Back Cushion ONLY Duration Vinyl	\$110.00
DR1102-Vinyl-UC	Upcharge Non Standard Vinyl DR1102 Upholstery upcharge	\$130.00
DR-1102-ULTR-UC	Upcharge Ultra leather DR1102 Upholstery upcharge	\$250.00
DR-5109-Vinyl-UC	Upcharge Non Standard Vinyl DR5109 Upholstery upcharge	\$150.00
DR-5109-ULTR-UC	Upcharge Ultra leather DR5109 Upholstery upcharge	\$290.00
SS-5105-Vinyl-UC	Upcharge Non Standard Vinyl SS5105 Upholstery upcharge	\$140.00
SS-5105-ULTR-UC	Upcharge Ultra leather SS5105 Upholstery upcharge	\$270.00

Mirage

Assistants Stool

Model AS-1101



Dimensions:

Backrest vertical adjustment range: 0" – 3.25"
 Seat width: 18"
 Seat height ranges: 19" –23"
 5-Leg base diameter: 24"
 Packing dimensions: 24" x 23" x 20" / 45 lbs.

Model HY-1107



Dimensions:

Backrest vertical adjustment range: 0" – 3.25"
 Seat width: 18"
 Seat height ranges: 19" –23"
 5-Leg base diameter: 24"
 Packing dimensions: 22" x 21" x 15" / 30 lbs.

Description	Model	Suggested Retail Price
Mirage assistants stool	AS-1101	\$550
Mirage hygiene stool	HY-1107	\$460

Stool Package includes the following:

Five-leg, ultra stable base, 24" diameter	✓	✓
Gas cylinder lift for seat height adjustment	✓	✓
Large, firm cushion seat	✓	✓
Durable tile / carpet Casters	✓	✓
Adjustable full ring foot rest	✓	
Adjustable for right or left handed use	✓	
Adjustable anatomical body support bar	✓	
Seat tilt		✓
Height adjustment	22" - 29"	19" - 23"
1 year warranty	✓	✓

Options *Specify Color And Product Code*

AS1101-16	Replacement AS1101 Seat Cushion ONLY Duration Vinyl	\$140.00
AS1101-21	Replacement AS1101 Chair Back Cushion ONLY Duration Vinyl	\$110.00
AS1101-18	Replacement AS1101 Abdominal Bar Cushion ONLY Duration Vinyl	\$105.00
AS1101-Vinyl-UC	Upcharge Non Standard Vinyl AS1101 Upholstery Upcharge	\$150.00
AS1101-ULTR-UC	Upcharge Ultra leather AS1101 Upholstery Upcharge	\$290.00

Mirage

X-ray Chair



Model XR-6101

Dimensions:

- Seat width: 21"
- Seat height ranges: 21.5" – 27.5"
- Base diameter: 24"
- Packing dimensions: 31" x 20" x 11" / 46 lbs.
- 8" x 8" x 18" / 17 lbs.
- 24" x 24" x 4" / 14 lbs.

Description	Model	Suggested Retail Price
Mirage Xray chair	XR-6101	\$1,100

X-ray stool Package includes the following:

Adjustable headrest	✓	
Gas cylinder lift for seat height adjustment	✓	
Pneumatic pump on base	✓	
Large, firm cushion seat	✓	
Large diameter base	✓	
Height adjustment	✓	21.5" - 27.5"
16 Upholstery color choices	✓	
Arm rest	✓	
Leg rest	✓	
1 year warranty	✓	

Options

XR-6101-8-C	Replacement XR6101 Duration Vinyl Seat Cushion ONLY	\$120.00
XR-6101-9-C	Replacement XR6101 Duration Vinyl Chair Back Cushion ONLY	\$140.00
XR-6101-10-C	Replacement XR6101 Duration Vinyl Headrest Cushion ONLY	\$78.00
XR-6101-Vinyl-UC	Upcharge Non Standard Vinyl XR6101 Upholstery Upcharge	\$290.00
XR-6101-ULTR-UC	Upcharge Ultra leather XR6101 Upholstery Upcharge	\$460.00

Lucent LED

Operatory Light



Model #L600-LED



Model L690-LED
Ceiling mounted
Lucent LED
operatory light.

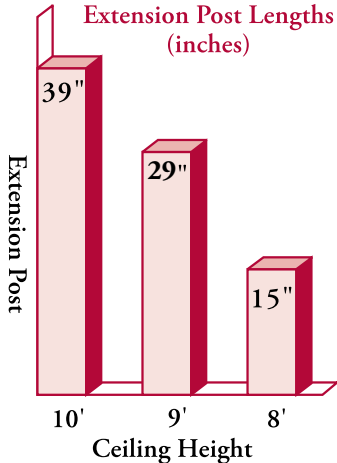

Packing Dimensions (L x W x H)	Weight
L900-08: 15 x 3 x 3	3 lbs.
L900-09: 30 x 3 x 3	5 lbs.
L900-10: 44 x 4 x 4	7 lbs.

#LP48 Light Post must be ordered if dental light is ordered separately

Specifications:

Absorbed Power:	Max 8vA
Input voltage:	110V/220V, 60/50 Hz
Output voltage:	24 Volts AC / DC

Light intensity (Lux):	3,000 - 35,000 Lux @ 700mm
Cooling System:	Static Heat sink (no fan)
Illumination area:	100mm x 180mm @ 700mm

Description

Model

Suggested Retail Price

Lucent LED Post Mount Operatory Light	L600-LED	\$1,280
Lucent LED Post Mount Operatory Light with motion sensor	L625-LED	\$1,430
Lucent LED Ceiling Mounted Light (specify 8', 9' or 10' ceiling)	L690-LED	\$1,840
Lucent LED Ceiling Mounted Light (specify 8', 9' or 10' ceiling) with motion sensor	L695-LED	\$1,990

Package includes the following:

Input voltage 110V	✓	✓	✓	✓
2 year warranty	✓	✓	✓	✓

Options:

		Retail
RLL-H04	Replacement LED light optical bulb group	\$250.00
RLL-H06	Replacement light handle (Left and Right)	\$90.00
RLL-H01	Replacement shield	\$73.00
RLL-H03	Replacement reflector / set of 2	\$96.00
RLL-PS	110 - 240 V Power supply in 24 V out	\$78.00
LP-48	48" light post	\$149.00
L900-08	Ceiling post for 8' ceiling height	\$176.00
L900-09	Ceiling post for 9' ceiling height	\$176.00
L900-010	Ceiling post for 10' ceiling height	\$176.00

Packing Dimensions (L x W x H)	Weight
L600: 38 x 17 x 15	28 lbs.
L690: 38 x 17 x 15	34 lbs.

Advance

Operatory Light



#LP48 Light Post must be ordered if dental light (#L800 or #L700) is ordered separately

Specifications:

Halogen lamp:	12 Volts, 55 Watts	Light intensity (Lux):	High 24,000; Low 12,000
Input voltage:	110V, 60 Hz	Focal length:	27" (70 cm)
Output voltage:	High 12V; Low 10.5V	Illumination area:	3" x 7" at focal length
Color temperature:	4500° K	Shipping Dimensions:	26"L x 14"W x 8" H / 21 lbs.
Bulb type:	H3		

Description	Model	Suggested Retail Price
Advance Operatory Light (white)	L700-1	\$920
Advance Operatory Light (Grey)	L700-1-G	\$920

Package includes the following:

Input voltage 110V	✓
1 year warranty	✓

Options:

		Retail
P901	Replacement light bulb	\$15.00
P702	Replacement light handle	\$52.00
P703-N	Replacement shield	\$27.00
P705	Replacement reflector	\$160.00
P56004-700	Transformer	\$120.00
LP-48	48" light post	\$149.00



Radiant LED

Operatory Light

Model #R6101-LED



Radiant light handles are removable and sterilizable

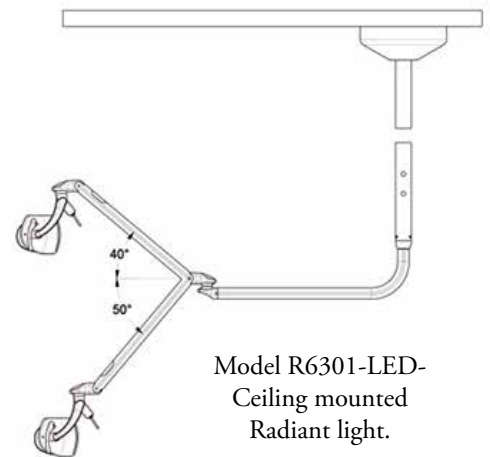
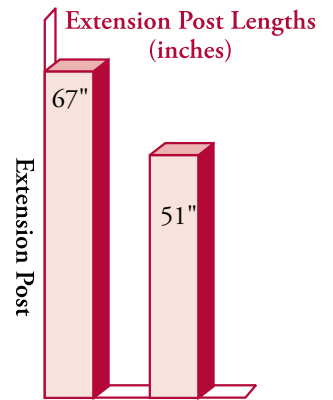

Model R6301-LED-Ceiling mounted Radiant light.

#LP48-RI Light Post must be ordered if dental light is ordered separately
Specifications:

Absorbed Power:	Max 8vA	Light intensity (Lux):	3,000 - 35,000 Lux @ 700mm
Input voltage:	110V/220V, 60/50 Hz	Cooling System:	Static Heat sink (no fan)
Output voltage:	24 Volts AC / DC	Illumination area:	100mm x 180mm @ 700mm
Bulb type:	LED		

Description	Model	Suggested Retail Price
Radiant LED Operatory Light	R6101-LED	\$1,550
Radiant LED Operatory Light with motion sensor	R6105-LED	\$1,700
Radiant LED Ceiling Mounted Light (specify 9' or 10' ceiling)	R6301-LED	\$2,750
Radiant LED Ceiling Mounted Light motion sensor (specify 9' or 10' ceiling)	R6305-LED	\$2,900

Package includes the following:

Input voltage 110V - 240 Vac	✓	✓	✓
2 year warranty	✓	✓	✓

Options:	Retail
RLL-H04 Replacement LED light optical bulb group	\$250.00
RLL-H06 Replacement light handle (Left and Right)	\$90.00
RLL-H01 Replacement shield	\$73.00
RLL-H03 Replacement reflector / set of 2	\$96.00
RLL-PS 110 - 240 V Power supply in 24 V out	\$78.00
LP-48-RI 48" light post	\$149.00
R-08500 Wall Mount Bracket	\$550.00

Nylon Bushing

#LP-RI-S Included with models R6101-LED, R6105-LED
 • OD 1 7/8"
 • ID 1 3/8"

Packing Dimensions (L x W x H)	Weight
Arm: 45 x 20 x 7	14 lbs.
Head: 14 x 14 x 9	6 lbs.
Ceiling Kit : 15 x 15 x 9	13 lbs.

Packing Dimensions (L x W x H)	Weight
Post 52": 57 x 3 x 3	13 lbs.
Post 68": 73 x 3 x 3	19 lbs.



Luminous

LED Operatory Light
with *PoliBlock Filter*



Luminous light handles are removable and sterilizable

#LP48-RI Light Post must be ordered if dental light is ordered separately
Specifications:

Absorbed Power:	Max 8vA	Light intensity (Lux):	3,000 - 35,000 Lux @ 700mm
Input voltage:	110V/220V, 60/50 Hz	Cooling System:	Static Heat sink (no fan)
Output voltage:	24 Volts AC / DC	Illumination area:	100mm x 180mm @ 700mm
Bulb type:	LED		

Description	Model	Suggested Retail Price
Luminous LED Operatory Light	L-7601-LED	\$2,990

Package includes the following:

Input voltage 110V - 240 Vac
2 year warranty



Options:

Retail

Nylon Bushing

#LP-RI-S Included with models
• OD 1 7/8" R6101-LED, R6105-LED
• ID 1 3/8" 

Packing Dimensions (L x W x H)	Weight
Light: 37" x 16" x 15"	18 lbs.

Mobile Cabinet Systems



Utility Mobile Cabinet
#TMC-180

- 14.5" W x 16" D x 32" H
- designed for ultrasonic scalers, curing lights, electrasurge, intraoral cameras, etc.
- 1 instrument drawer
- 2 adjustable shelves
- 1 year warranty
- shipping dimensions: 24" x 24" x 37" / 72 lbs.



Doctor's Mobile Cabinet
#TMC-140

- 21.5" W x 19" D x 32" H
- 4 instrument drawers
- 3 storage drawers
- 1 year warranty
- shipping dimensions: 27" x 25" x 36" / 116 lbs.



Assistant's "Alabama" Mobile Cabinet
#TMC-160

- 21.5" W x 19" D x 32" H
- sliding counter top with amalgamator well
- 1 instrument drawer
- 2 storage drawers
- side to side sliding counter
- 1 year warranty
- shipping dimensions: 25" x 23" x 35" / 89 lbs.



Assistant's "North Carolina" Mobile Cabinet
#TMC-120

- 21.5" W x 19" D x 32" H
- solid top with pull handle
- amalgamator well drop leaf door
- 3 instrument drawers
- 1 storage drawer
- 1 year warranty
- shipping dimensions: 25" x 23" x 36" / 112 lbs.



- White will be shipped if color choice not indicated on purchase order
- Mobile cabinets ship on pallet via freight carrier

Description	Model (light grey)	Model (white)	Suggested Retail Price
Utility Mobile Cabinet	TMC-180-G	TMC-180-W	\$340
Doctor's Mobile Cabinet	TMC-140-G	TMC-140-W	\$720
Assistant's "Alabama" Mobile Cabinet	TMC-160-G	TMC-160-W	\$720
Assistant's "North Carolina" Mobile Cabinet	TMC-120-G	TMC-120-W	\$720
Assistant's "North Carolina" Mobile Cabinet RT pull out		TMC-120R-W	\$720

Package includes the following:

External surfaces of high pressure laminate with complimentary white interior surface for easy cleaning. Smooth flowing ball bearing glides. Durable casters. Color choice: white or light grey. 1 year warranty



17" LCD Monitor

Multimedia Monitor



Intraoral Camera Port



Multimedia Input port

- Multimedia Monitor
- Glass panel
- 4:3 Screen
- DVD, Intraoral Camera READY!!
- Full 17" viewable TFT Active Matrix flat panel display
- Auto adjustment function
- Built-in dual speakers
- On screen display controls (OSDC)
- Recommended resolution: 1280 x 1024 (17")
- Universal 100-240 VAC, 50/60 Hz
- Gross weight: 11.6 lbs
- Includes: AC adapter, remote control, Monitor Handle, Camera Holder
- Connections: Video-in, HDMI, RGA-in, audio-in, DC-in, Flash Drive Media Player
- 1 year warranty

Description

Model

Suggested Retail Price

17" LCD multi media monitor

M017

\$500

Shipping Dimensions 17" Monitor: 18" x 6" x 21" / 12 lbs.
(2/cs.) 19" x 12" x 22" / 27 lbs.

LCD Monitor Brackets

Monitor Brackets



WIC800



WIC825



WIC840

Standard LCD Monitor Bracket

- easily position the angle of your monitor for maximum comfort and productivity
- 4-way pivot adjustment
- standard 75mm spacing
- 1 Year warranty

Packing Dimensions:

11" x 7" x 6" 6 lbs.

(4/cs.) 15" x 12" x 11" 25 lbs.

Deluxe LCD Monitor Bracket

- 16" extension arm
- vertical and horizontal travel
- 4-way pivot adjustment
- standard 75mm spacing
- 1 Year warranty

Packing Dimensions:

14" x 12" x 6" 12 lbs.



Mirage Monitor Bracket

- 16" extension arm
- horizontal travel
- 4-way pivot adjustment
- standard 75mm spacing
- 1 Year warranty

Packing Dimensions:

15" x 10" x 5" 9 lbs.

WIC875



Monitor Adapter for AdvanceCAM Intraoral Camera & Docking Station

WIC865



Standard and Deluxe LCD Monitor Bracket may be wall mounted

- 1 year warranty

M100mm



Expansion Plate for 100mm Spacing

- 1 year warranty

Description

Model

Suggested Retail Price

Description	Model	Suggested Retail Price
Standard LCD Monitor Bracket	WIC800	\$118
Deluxe LCD Monitor Bracket with 16" Extension Arm	WIC825	\$360
Mirage LCD Monitor Bracket with 16" Extension Arm	WIC840	\$190
Expansion Plate for 100 mm spacing pattern	M100mm	\$22
Wall Plate Adapter	WIC865	\$90
Monitor Adapter for AdvanceCAM Intraoral Camera & Docking Station	WIC875	\$80

Super Thin

LED X-Ray Viewer

XV100 Viewer and
XV150-R Bracket



Mounted to Unit Head



Countertop Unit

- Viewing Area: 8.5" H x 11" W x 0.5" Thick
- Countertop, wall, or unit head mounted
- AC power source
- Sealed LED lights
- Instant illumination
- No grey in viewing area
- Viewing area accepts panoramic, cephalometric and regular size film
- 0.5" super thin viewer
- 1 year warranty



Wall Mounted

XV150
Assembly



XV150-R
*Mount to TPC
Mirage Unit (Round Arm)



XV150-F
*Mount to Flat Arm

Description

Model

Suggested Retail Price

Super Thin X-ray Viewer

XV100

\$140

Package Dimensions: 17" x 11" x 2" / 3 lbs.
(10/cs.) 17" x 11" x 19" / 28 lbs.

Options:

Retail

XV150-R Xray viewer bracket (round cut-out) – mount to Mirage unit head (Round Arm)

\$80.00

XV150-F Xray viewer bracket (flat cut-out) – mount to unit head (Flat Arm)

\$80.00

XV130 Replacement LED light strip

\$30.00

XV100-PSW Viewer replacement power supply

\$24.00

XV100-CLIP Viewer replacement Clip (3 Pack)

\$16.00

AIC5899



Specifications

- Imager Sony 1/4" CCD
- Capture Size 640 X 480
- Light Source 6 White LEDs
- Power USB 5VDC
- Frame Rate 30 fps MAX
- PC connection USB 2.0 Port

System Requirements

- Intel Pentium 4 .15 GHZ or Higher
- 512 MB RAM or higher
- Windows XP or higher
- USB 2.0 port



Description

Corded Direct USB Camera System

Model

AIC5899

Suggested Retail Price

\$790

Options:

- AIC500 Advance Cam Barriers, 500 / Box
- AIC930 Advance Cam Camera Holder
- AIC928-USB Advance Cam USB Camera Cable

Retail

- \$170.00
- \$30.00
- \$63.00

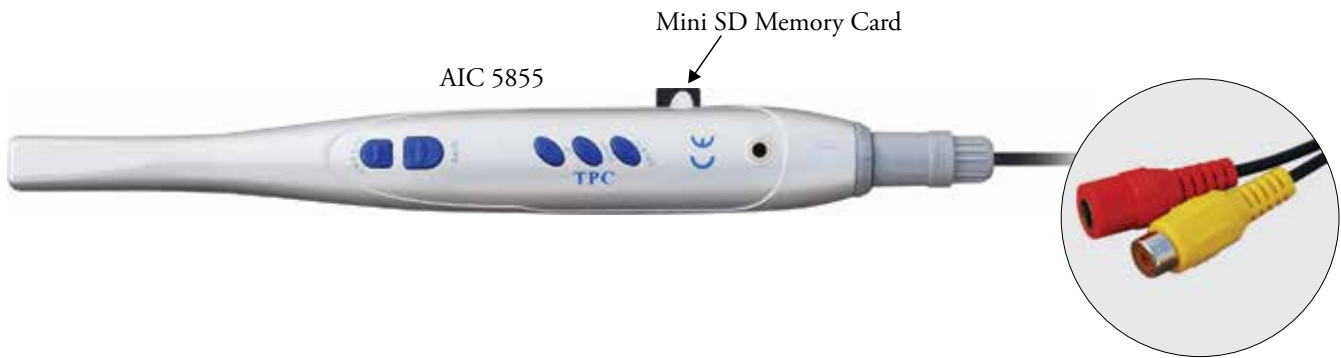

Specifications

- Imager Sony 1/4" CCD
- Capture Size 640 X 480
- Light Source 6 White LEDs
- Power 5VDC
- Supported Mini SD Up to 16GB



Optional
AIC500

Description

Model

Suggested Retail Price

Mini SD Card Camera System (Both Corded and Cordless)	AIC 5855-PKG (Includes: AIC5855+5901+5111)	\$1,090
--	---	---------

Options:

Retail

AIC5855 Advance Cam Intraoral Camera (Corded Only) with Mini SD Card	\$760
AIC5901 Mini SD Cam Power Supply	\$150
AIC500 Advance Cam Barriers, 500 / Box	\$170
AIC5111 Camera Mounted LCD Display 2.5"	\$140



AIC5888

AIC5900

Optional
AIC5111



AIC705
(USB)



Specifications

- Imager Sony 1/4" CCD
- Capture Size 640 X 480
- Light Source 6 White LEDs
- Power USB 5VDC
- Frame Rate 30 fps MAX
- PC connection USB 2.0 Port
- Power USB port 5V DC
- Frequency 2.4 Ghz

System Requirements

- Intel Pentium 4 .15 GHZ or Higher
- 512 MB RAM or higher
- Windows XP or higher
- USB 2.0 port



Description

Cordless USB Camera System

Model

WL-USBCAM-PKG
(Includes: AIC5888+705+5900)

Suggested Retail Price

\$960

Options:

		Retail
AIC5888	Advance Cam Intraoral Camera	\$680.00
AIC 705	Wireless USB Receiver	\$180.00
AIC 5900	Wireless Transmitter	\$196.00
AIC8.5v	Transmitter Charger	\$28.00
AIC5111	Camera Mounted LCD Display 2.5"	\$140.00
AIC500	Advance Cam Barriers, 500 / Box	\$170.00



Specifications

- Imager Sony 1/4" CCD
- Capture Size 640 X 480
- Light Source 6 White LEDs
- Power USB 5VDC
- Frame Rate 30 fps MAX
- Connections AV & Composite VGA, HDMI
- Frequency 2.4 Ghz
- Memory Micro SD 4 gb

System Requirements

- Intel Pentium 4 .15 GHZ or Higher
- 512 MB RAM or higher
- Windows XP or higher
- Optional: USB 2.0 port



Description

Corded Camera & Docking Station System

Model

AIC5888-5925W-KT (includes AIC5888+AIC5925)

Suggested Retail Price

\$1,130

Options:

		Retail
AIC5888	Advance Cam Intraoral Camera	\$680.00
AIC5925	Advance Cam Docking Station	\$520.00
AIC930	Advance Cam Camera holder	\$30.00
AIC5111	Camera Mounted LCD Display 2.5"	\$140.00
AIC500	Advance Cam Barriers, 500 / Box	\$170.00
AIC966	Wifi adaptor	\$150.00



Specifications

- Imager Sony 1/4" CCD
- Capture Size 640 X 480
- Light Source 6 White LEDs
- Power USB 5VDC - 12VDC
- Frame Rate 30 fps MAX
- Connections USB, AV, Composite, VGA, HDMI
- Memory SD Memory Card 4 GB
- Frequency 5.8 Ghz



Description

Cordless Camera & Docking Station System

Model

WL-CAM+DS-PKG
(Includes: AIC5888+5925W+5900+5920)

Suggested Retail Price

\$1,380

Options:

		Retail
AIC5888	Advance Cam Intraoral Camera	\$680.00
AIC5925	Advance Cam Docking Station	\$520.00
AIC 5900	Wireless Transmitter	\$196.00
AIC5111	Camera Mounted LCD Display 2.5"	\$140.00
AIC500	Advance Cam Barriers, 500 / Box	\$170.00
AIC5920	Wireless Receiver	\$140.00
AIC966	Wifi Adaptor	\$150.00

17" LCD Monitor

Multimedia Monitor / Camera Combo



Features:

- Camera features a 1/4" High Definition image sensor
- 17" Monitor features a High Definition resolution of 1280 X 1024
- Full USB port allows for easy image transfer
- High Definition real time video input allows for quick playback and easy patient diagnosis
- Camera buttons are easily accessible to control capture and playback functions
- Camera is illuminated with six bright LEDs; giving the best contrast, definition and resolution
- Camera features an automatic gain control to automatically adjust the light intensity to the CCD
- Input supports: USB, VGA, HDMI and AV.
- Medial playback format includes: MP3 audio, MP4 video and JPG images
- Adjustments on monitor include: Contrast, brightness and color
- Monitor comes equipped with a medical grade tempered glass front panel to minimize scratches
- Monitor Language supported: English, Chinese, Spanish, German, Portuguese and Arabic
- 4gb memory card (included) allows for easy image transfer and patient file management
- Easy integration of LCD monitor with camera on the dental delivery unit due to no additional cabling needed



Description

Model

Suggested Retail Price

17" LCD monitor with integrated IO camera (corded) Includes: MO17, AIC5855A,	AIC2IN1W	\$1,200.00
17" LCD monitor with integrated IO camera (wireless) Includes: MO17, AIC5855A, AIC5920, AIC5900	AIC2IN1WL	\$1,490.00

Options:

Retail

AIC500	Advance Cam Barriers, 500 / Box	\$170.00
--------	---------------------------------	----------

Shipping Dimensions 17" Monitor: 18" x 6" x 21" / 12 lbs.
(2/cs.) 19" x 12" x 22" / 27 lbs.

17" LCD Monitor

Multimedia Monitor / Camera Combo



Features:

- Camera features a 1/4" High Definition image sensor
- 17" Monitor features a High Definition resolution of 1280 X 1024
- Full USB port allows for easy image transfer
- Camera buttons are easily accessible to control capture and playback functions
- Camera is illuminated with six bright LEDs; giving the best contrast, definition and resolution
- Camera features an automatic gain control to automatically adjust the light intensity to the CCD
- 5.8 GHz wireless transmission protocol
- Four channel wireless transmitter (AIC5900) and receiver (AIC5920)
- Input supports: USB, VGA, HDMI and AV.
- Medial playback format includes: MP3 audio, MP4 video and JPG images
- Adjustments on monitor include: Contrast, brightness and color
- Monitor comes equipped with a medical grade tempered glass front panel to minimize scratches
- Monitor Language supported: English, Chinese, Spanish, German, Portuguese and Arabic
- 4gb memory card (included) allows for easy image transfer and patient file management
- Optional WIFI transmitter allows images to be displayed on stand alone LCD monitor and remote computers simultaneously for easy consultation and image management transfer.
- Easy integration of LCD monitor with camera on the dental delivery unit due to no additional cabling needed

Description	Model	Suggested Retail Price
17" LCD monitor with integrated IO camera corded Includes: MO17DS, AIC5888A	AIC3IN1W	\$1,500.00
17" LCD monitor with integrated IO camera wireless Includes: MO17DS, AIC5888 A, AIC5920, AIC5900	AIC3IN1WL	\$1,780.00

Options:

		Retail
AIC500	Advance Cam Barriers, 500 / Box	\$170.00
AIC966	Wifi Adapter	\$150.00

Shipping Dimensions 17" Monitor: 18" x 6" x 21" / 12 lbs.
(2/cs.) 19" x 12" x 22" / 27 lbs.

EMC - 900

eTornado Electric Motor System



eTornado Electric Motor Features:

- Fiber Optic Brushless Electric Motor
- Two programmable settings for each mode
- Push Button control for easy operation
- Light weight, compact - ergonomical design
- Counter top system is easy to install and integrate
- Universal e-type connector compatible with most
- Speed range from 100 - 200,000 rpm

Specifications

- 2 General / Basic Endo Modes
- e-type attachment / coupling
- Manual reverse
- Unit Dimensions
4.5"W X 5.25" D X 2.5"H
- Motor weight: 87 grams
- Motor Length: 50mm
- Input Voltage: 100 - 240 Vac
- Output Voltage: 30Vac

Easy to install and integrate with any dental unit.

<u>Description</u>	<u>Model</u>	<u>Suggested Retail Price</u>
e Tornado Electric Motor System - Counter top	EMC-900	\$1,900

Package includes the following:

e Tornado Electric Motor System - Counter top	✓
Power Pack	✓
HP Tubing	✓
E600 Electric Motor up to 40,000 rpm	✓

Options

EMA150-FG	1:5 Friction Grip Attachment	\$1,160
EMA110-CA	1:1 Contra Angle Attachment	\$1,060
EMP30	Power Supply 30Vac, 4A for control box	\$140.00

Shipping Dimensions: 11" x 11" x 5" / 5 lbs.

EMB - 901

eTornado Electric Motor System



Electric Motor With Tubing



eTornado Control Box



eTornado Touchpad

eTornado Electric Motor Features:

- Fiber Optic Brushless Electric Motor
- Two programmable settings for each mode
- Push Button control for easy operation
- Light weight, compact - ergonomical design
- Built in system pre wired for easy installation
- Universal e-type connector compatible with most electric attachments
- Speed range from 100 - 200,000 rpm

Specifications

- 2 General / Basic Endo Modes
- e-type attachment / coupling
- Manual reverse
- Unit Dimensions
4.5"W X 5.25" D X 2.5"H
- Motor weight: 87 grams
- Motor Length: 50mm
- Input Voltage: 100 - 240 Vac

Description

eTornado Built in Electric Motor System

Model

EMB-901

Suggested Retail Price

\$1,790

Package includes the following:

- eTornado Electric Motor System - Built in
- Power Pack
- HP Tubing
- E600 Electric Motor up to 40,000 rpm

- ✓
- ✓
- ✓
- ✓

Options

- EMA150-FG 1:5 Friction Grip Attachment
- EMA110-CA 1:1 Contra Angle Attachment

- \$1,160
- \$1,060

Shipping Dimensions:

EMA-150FG

High Speed Contra Angle Attachment



EMA-110 CA

EMA-150FG

Description	Model	Suggested Retail Price
1:5 Friction Grip Attachment	EMA-150FG	\$1,160
1:1 Contra Angle Attachment	EMA-110CA	\$1,060
Package includes the following:		
Push Button Auto Chuck	✓	
Quatro Water Spray	✓	
Speed Range up to 200,000 rpm	✓	
Attachment to electric motor w/ E-type connection	✓	
Max Lux of 32,000	✓	

Shipping Dimensions:

High Speed Handpieces Overview

All High Speed Handpieces Use Ceramic Bearings

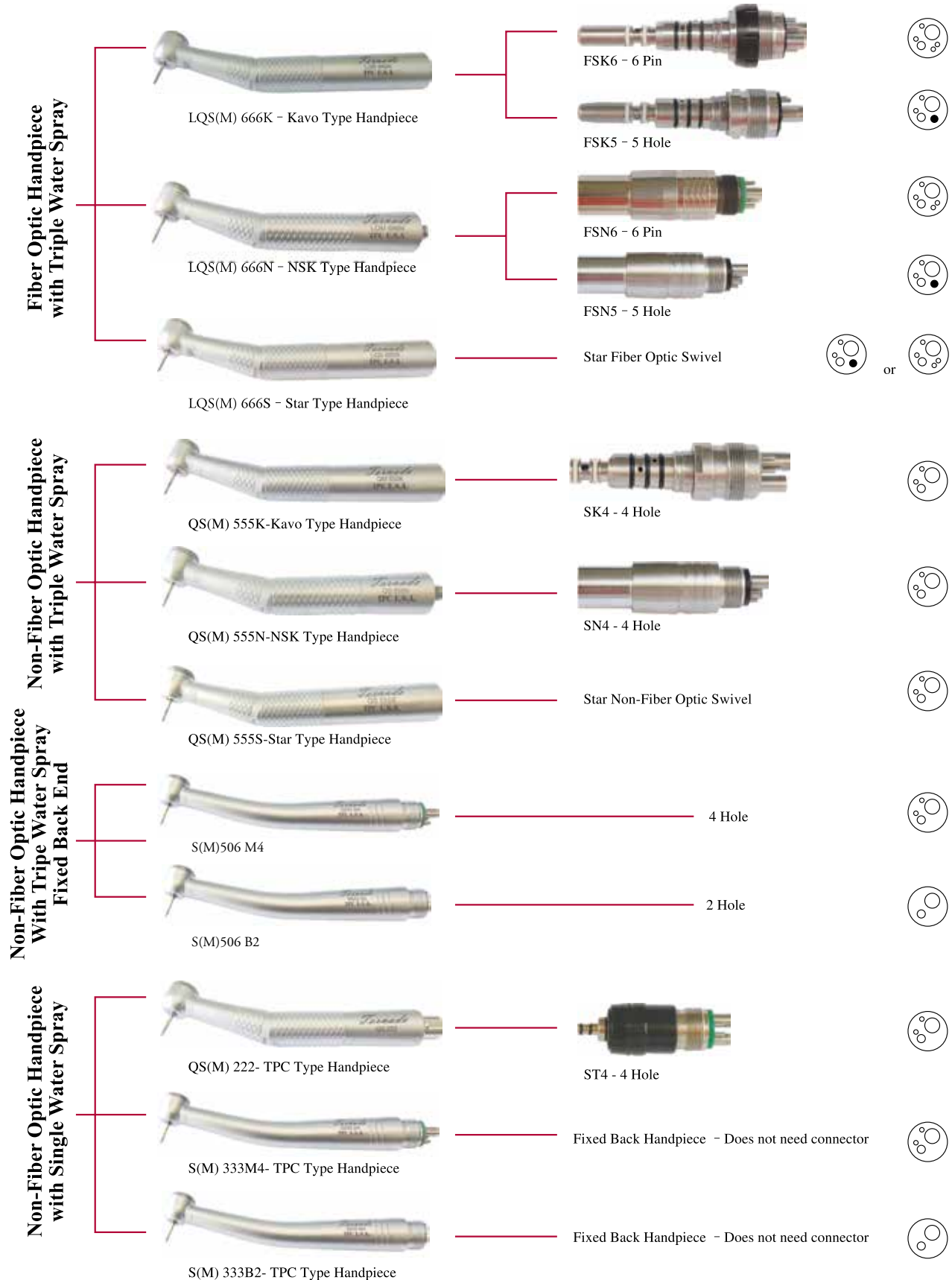

Fiber Optic Handpieces

Triple Water Spray / Push Button / Auto Chuck / Ceramic Bearing

Premius Series



Fiber Optic
w/Triple
Water Spray



LQS 666 (K,N,S)



Standard Head



LQM 666 (K,N,S)



Mini Head

FIBER OPTIC QUICK CONNECTORS

(Swivel)



FSK6 Kavo Type 6 Pin



FSK5 Kavo Type 5 Hole



FSN6 NSK Type 6 Pin

Description	Model	Suggested Retail Price
Kavo Type Fiber Optic HP <u>Standard</u> Head w/Triple Water Spray Fits Kavo Connector	LQS666K	\$690
Kavo Type Fiber Optic HP <u>Mini</u> Head w/Triple Water Spray Fits Kavo Connector	LQM666K	\$690
6 Hole (ISO-C) Fiber Optic Connector Fits Handpiece with KAVO "Multiflex" Quick Connector System	FSK6	\$240
5 Hole (Midwest) Fiber Optic Connector Fits Handpiece with KAVO "Multiflex" Quick Connector System	FSK5	\$240
NSK Type Fiber Optic HP <u>Standard</u> Head w/Triple Water Spray Fits NSK Connector	LQS666N	\$690
NSK Type Fiber Optic HP <u>Mini</u> Head w/Triple Water Spray Fits NSK Connector	LQM666N	\$690
6 Hole (ISO-C) Fiber Optic Connector Fits Handpiece with NSK Quick Connector System	FSN6	\$240
Star Type Fiber Optic HP <u>Standard</u> Head w/Triple Water Spray Fits Star Connector	LQS666S	\$690
Star Type Fiber Optic HP <u>Mini</u> Head w/Triple Water Spray Fits Star Connector	LQM666S	\$690

Non-Fiber Optic Handpieces

Triple Water Spray / Push Button / Auto Chuck / Ceramic Bearing

Optimus Series



Non-Fiber Optic
w/Triple
Water Spray



QS 555 (K,N,S)



Standard Head



QM 555 (K,N,S)



Mini Head

NON-FIBER OPTIC QUICK CONNECTORS

(Swivel)



SK4 Kavo Type 4 Hole



SN4 NSK Type 4 Hole

Description	Model	Suggested Retail Price
Kavo Type Non-Fiber Optic HP <u>Standard</u> Head w/Triple Water Spray Fits Kavo Connector	QS555K	\$520
Kavo Type Non-Fiber Optic HP <u>Mini</u> Head w/Triple Water Spray Fits Kavo Connector	QM555K	\$520
4 Hole Non-Fiber Optic Connector Fits Handpiece with KAVO "Multiflex" Quick Connector System	SK4	\$130
NSK Type Non-Fiber Optic HP <u>Standard</u> Head w/Triple Water Spray Fits NSK Connector	QS555N	\$520
NSK Type Non-Fiber Optic HP <u>Mini</u> Head w/Triple Water Spray Fits NSK Connector	QM555N	\$520
4 Hole Non-Fiber Optic Connector Fits Handpiece with NSK Quick Connector System	SN4	\$130
Star Type Non-Fiber Optic HP <u>Standard</u> Head w/Triple Water Spray Fits Star Connector	QS555S	\$520
Star Type Non-Fiber Optic HP <u>Mini</u> Head w/Triple Water Spray Fits Star Connector	QM555S	\$520

Non-Fiber Optic Handpieces (Standard Back End)

Triple Water Spray / Push Button / Auto Chuck / Ceramic Bearing

Triton Series



Non-Fiber Optic
w/Triple
Water Spray



S504 M4 / S506 M4



Standard Head



S504 M4 / M506 M4



Mini Head

Description	Model	Suggested Retail Price
Non-Fiber Optic HP <u>Standard</u> Head w/Triple Water Spray Standard Back End-4 Hole	S504M4 / S506M4	\$490
Non-Fiber Optic HP <u>Mini</u> Head w/Triple Water Spray Standard Back End-4 Hole	M504M4 / M506M4	\$490
Non-Fiber Optic HP <u>Standard</u> Head w/Triple Water Spray Standard Back End-2 Hole	S502B2	\$490
Non-Fiber Optic HP <u>Mini</u> Head w/Triple Water Spray Standard Back End-2 Hole	M502B2	\$490

Non-Fiber Optic Handpieces

Single Water Spray / Push Button / Auto Chuck / Ceramic Bearing

Nexius Series



Non-Fiber Optic
w/Single
Water Spray



QS 222 Standard Head



Standard Head



QM 222 Mini Head



Mini Head

NON-FIBER OPTIC QUICK CONNECTORS (Swivel)



ST4 TPC Type 4 Hole

Description	Model	Suggested Retail Price
Non-Fiber Optic HP (Standard Head) with Single Water Spray Fits TPC Connector	QS222	\$440
Non-Fiber Optic HP (Mini Head) with Single Water Spray Fits TPC Connector	QM222	\$440
4 Hole Non-Fiber Optic Connector Fits Handpiece with TPC Quick Connector System	ST4	\$80

Non-Fiber Optic Handpieces (Standard Back End)

Single Water Spray / Push Button / Auto Chuck / Ceramic Bearing

Nexius Series



Non-Fiber Optic
w/Single
Water Spray



S333M4 Standard Head



Standard Head



M333M4 Mini Head



Mini Head

Description	Model	Suggested Retail Price
Push Button Autochuck (Standard Head) with Single Water Spray Standard Back End -4 Hole	S333M4	\$310
Push Button Autochuck (Mini Head) with Single Water Spray Standard Back End -4 Hole	M333M4	\$310
Push Button Autochuck (Standard Head) with Single Water Spray Standard Back End -2 Hole	S333B2	\$310
Push Button Autochuck (Mini Head) with Single Water Spray Standard Back End -2 Hole	M333B2	\$310

Low Speed Handpieces

External Water Coolant

Internal Water Coolant

Exomus Series



ELM 744: Air Motor, Speed range up to 20,000 rpm, forward / reverse speed adjustment



ELS 736: Transmission 1:1, speed range up to 20,000 rpm



ELCA 760: Transmission 1:1, push button autochuck, for latch burs



ELCA 762: Transmission 1:1, latch type, for latch burs

Inximus Series



ILM 844: Air Motor, Speed range up to 20,000 rpm, forward / reverse speed adjustment, internal air/water coolant



ILS 836: Transmission 1:1, internal water spray



ILCA 860: Transmission 1:1, internal water spray, push button auto chuck for latch burs



Description	Model	Suggested Retail Price
External Water Low Speed Complete package includes (air motor, straight nose cone HP, Push button contra angle HP)	ELK700-M4	\$748
External Water Low Speed Complete package includes (air motor, straight nose cone HP, Latch type contra angle HP)	ELK702-M4	\$618
Low Speed Motor, External Water, 20,000 rpm (4 hole)	ELM744-M4	\$320
Low Speed Motor, External Water, 20,000 rpm (2 hole)	ELM722-B2	\$320
Straight nose cone HP, 1:1	ELS736	\$178
Push button contra angle HP, Complete 1:1	ELCA-760	\$320
Latch type contra angle HP, Complete 1:1	ELCA-762	\$178
Internal Water Low Speed Complete package includes (air motor, straight nose cone HP, push button contra angle HP)	ILK800-4	\$1,360
Low Speed Motor (Internal Water) 20,000 rpm-4 hole	ILM844-4	\$500
Straight nose cone HP, 1:1	ILS836	\$480
Push Button Contra Angle HP, Complete 1:1	ILCA860	\$500

Prophy Aide

Hygiene Prophy Handpiece



Description

Model

Prophy Aide Hygiene Handpiece
 Prophy Aide Hygiene Handpiece
Package includes the following:

PH-777 (Red) \$398
 PH-777 (BLK) \$398

- 4 Hole fixed back end
- 5,000 RPM
- Twist open chuck
- 360 Head Swivel Capabilities
- Forward and Reverse operation

- ✓
- ✓
- ✓
- ✓
- ✓

Fiber Optic Light Source

Light Source Package



H 7070
Fiber Optic Light Bulb
Cartridge



H 7040
Fiber Optic 5-Hole Tubing



H 7020
Control Board



H 7045
Fiber Optic 6-Pin Tubing



H 7090
Fiber Optic Transform



H 7660 - 6 Pin

Package includes: H7020+H7045+H7090



H 7000 - 5 Hole

Package includes: H7020+H7040+H7070+H7090

Description	Model	Suggested Retail Price
TPC Fiber Optic Light Source System- 6 Pin Package includes: Control board, Fiber Optic HP Tubing, Transformer	H7660	\$238
TPC Fiber Optic Light Source System- 5 Hole Package includes: Control board, Fiber Optic HP Tubing, Transformer, Bulb Cartridge	H7000	\$278
TPC Fiber Optic Control Board (accepts two Fiber Optic HP Tubing)	H7020	\$129
TPC Fiber Optic HP Tubing-6 Pin, Grey	H7045	\$108
TPC Fiber Optic HP Tubing- 5 Hole, Grey	H7040	\$108
TPC Fiber Optic Light Bulb Cartridge	H7070	\$50
TPC Fiber Optic Light Source Transformer	H7090	\$22

Replacement Turbines & Parts

Handpiece Replacement Parts

REPLACEMENT TURBINES

Item #	Description	Retail
TRT 110S	Replacement turbine fits Tornado HP LQS 666, QS 555, Standard Head	\$250
TRT 115M	Replacement turbine fits Tornado HP LQM 666, QM 555, Mini Head	\$250
TRT 120S	Replacement turbine fits Tornado HP S333, Standard Head	\$218
TRT 122S	Replacement turbine fits Tornado HP QS222, Standard Head	\$218
TRT 125M	Replacement turbine fits Tornado HP QM222, M333, Mini Head	\$218
TRT 130	Push button turbine fits Kavo Super Torque 630 B/C and 640 B/C	\$250
TRT 135	Push button turbine fit for Kavo Super Torque 647B and 649 B	\$250
TRT 140	Push button turbine fit for Kavo Bella Torque 639B/C and 642 B/C	\$250
TRT 145	Push button turbine fit for Kavo Mira 635 B	\$250
TRT 150	Push button turbine fit for Star 430 Series Handpiece	\$250
TRT 155	Turbine fit for Midwest Quiet Air L F.O & Non F.O. HP	\$250
TRT 160	Turbine fit for Midwest Tradition L F.O & Non F.O. HP	\$250
TRT 165	Turbine fit for Midwest Tradition F.O & Non F.O. HP	\$130
TRT 170	Turbine fit for Midwest XGT/Tradition PB F.O & Non F.O. HP	\$250

REPLACEMENT PARTS

Item #	Description	Retail
TRP 213	Replacement Light Bulb for FSK6 (Kavo Type Quick Connector)	\$27
TRP 215	Replacement Light Bulb for FSN6 (NSK Type Quick Connector)	\$27
TRP 220	Back Cap Removal Tool for LQS 666, QS 555	\$18
TRP 222	Back Cap Removal Tool for LQM 666, QM 555	\$18
TRP 224	Back Cap Removal Tool for QS 222	\$18
TRP 226	Back Cap Removal Tool for QM 222, M 333	\$18
TRP 228	Back Cap Removal Tool for S 333	\$7
TRP 231	Replacement Push Button Cap for LQS 666, QS 555	\$46
TRP 233	Replacement Push Button Cap for LQM 666, QM 555	\$46
TRP 235	Replacement Push Button Cap for QS 222	\$46
TRP 237	Replacement Push Button Cap for QM 222, M 333	\$46
TRP 239	Replacement Push Button Cap for S 333	\$46
TRP 240	Replacement O Ring for FSK6, FSK5, Sk4 (Pack of 5 (2 white, 3 black))	\$9.50

H6000

Handpiece Lubrication System

Product Features

- Economical, efficient and time-saving
- A fail-safe maintenance solution for your office
- Filtered air used to rotate handpieces for safety
- Care for most handpieces and all handpieces brands
- Disposable mist filtration system
- Solution level indicator
- Detachable door for easy cleaning of unit
- Easy replenishment of solution tank
- Air Pressure guage
- Oil flow control valve



H6000
(3 high speed positions)



• Saves Time

• Simple to Operate

• Optimizes Performance



H6005

- 2 high speed positions
- 1 low speed E-type motor



H6025

- 1 high speed positions
- 2 low speed E-type motor



H6150-Kavo
kavo maintenance coupler



H6165-W&H
W&H maintenance coupler



H6160-BienAir
BienAir maintenance coupler



H6155-NSK
NSK maintenance coupler



H6145-MW
Quick Connect for Midwest Slow Speed



H6175-E-Type
4 Hole to E-Type Adaptor

Description	Model	Suggested Retail Price
H6000 Handpiece cleaning and lubrication system	H6000	\$1,250
H6005 Handpiece cleaning and lubrication system	H6005	\$1,300
H6025 Handpiece cleaning and lubrication system	H6025	\$1,350

Package includes the following:

3 high speed handpiece positions	✓		
2 high speed / 1 low speed E-type Motor		✓	
1 high speed / 2 low speed E-type Motor			✓
Mist filters (pack of 12)	✓	✓	✓
Lubrication fluid	✓	✓	✓
Air filter	✓	✓	✓

Options:

	Retail
H6125 Lubrication fluid	\$40.00
H6130 Mist filter (pack of 12)	\$20.00
H6135 Oil absorbent door strips (pack of 20)	\$16.00
H6150-Kavo Kavo Type HP adapter	\$102.50
H6155-NSK NSK Type HP adapter	\$102.50
H6160-BienAir Bien Air Type HP adapter	\$102.50
H6165-W&H W&H Type HP adapter	\$102.50
H6145-MW Quick Connect for Midwest Slow Speed	\$102.50
H6175-E-Type 4 Hole to E-Type Adaptor	\$102.50

Packing Dimensions: 17"L x 15"W x 18"H / 24 lbs.

Advance 2500

LED Bleaching System

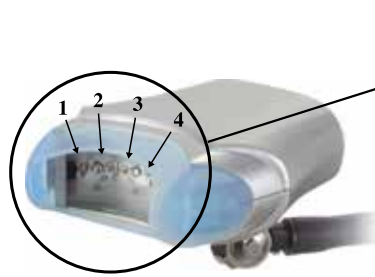

Model #2500

Features

- Quiet fan operation
- Multi-arch whitening application
- Three high intensity LED's
- Digital display with audio feedback
- High power Blue and UV light emitting diodes
- Compact mobile stand for easy storage
- Adjustable bleaching time with microprocessor-controlled timer
- Smart auto-select power: 110-240 Volts AC, 50/60 Hz
- LED bleaching system includes illuminator, mobile base, adjustable arm, power cord & user manual
- 1 year warranty

Specifications:

Broad-spectrum:	395–490 nm
Light intensity:	1,500 mW/cm ²
Weight:	14 lbs.
Dimensions:	60" (H) X 20" (W)
Voltage output:	110-240 V / 50-60 Hz
Packing Dimensions:	21" x 21" x 6" / 14lbs.



Description

Advance 2500 LED Bleaching Light

Model

ALED 2500

Suggested Retail Price

\$1,300

Package includes the following:

Advance 2500LED Bleaching Light	✓
Mobile stand	✓
AC power supply	✓
1 Year warranty	✓



LED 70N

Cordless Curing Light System



Features

- Low battery signal – visual and audible alarm
- Easy to read – LCD display
- High light intensity – 5 to 10 second cure
- No down time
- Flexibility – corded and cordless light cure
- Quiet fan – extends life of LED
- Sleep mode – conserves power, saves battery life
- Fast mode – 3 output modes 2,000 – 1,500 – 1,000
- Built-in radiometer

Specifications and Accessories

Switching Power Adapter

Power supply: AC 100-240V / 50-60 Hz
 Dimensions: 10"L x 2"W x 8"H

Hand Piece

Light source: 10W light emitting diode
 Wavelength: 430-490 nm
 Light Intensity: 2,000 mW/cm²
 Battery: Lithium ion

Standard Accessories

- LED 70 Handpiece
- Charging base
- 8mm light guide
- Eye protector
- Lithium ion battery
- Power supply
- User's Manual

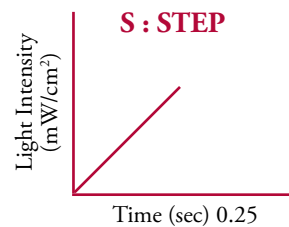
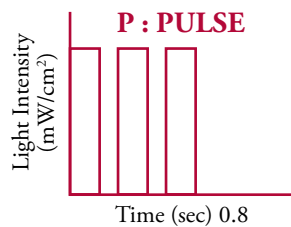
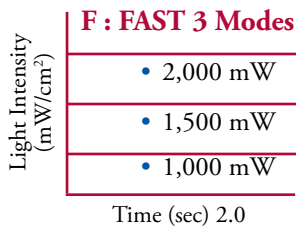

Description

LED 70 Cordless Curing Light

Model

ALED-70

Suggested Retail Price

\$640

Package includes the following:

- LED 70 Cordless Curing Light ✓
- Charging Base ✓
- Protective Eye-shield ✓
- Countertop Stand with Power Indicator ✓
- 8mm Light Guide ✓
- Built-in radiometer ✓
- AC power supply ✓

Options:

		Retail
P109-LG	Replacement light guide (8mm)	\$78.00
P208	Replacement protective eye-shield	\$10.00
ALED 70N-BATT	Replacement rechargeable battery for LED 70	\$80.00
P117	11mm light guide	\$105.00

Shipping Dimensions: 11"L x 8"W x 4"H / 3 lbs.
 (10/cs.) 18"L x 12"W x 16"H / 25 lbs.



LED 60N

Cordless Curing Light System



Specifications and Accessories

Switching Power Adapter

Power supply: AC 100-240V / 50-60 Hz

Dimensions: 10"L x 2"W x 8"H

Hand Piece

Light source: 5W light emitting diode

Wavelength: 430-490 nm

Light Intensity: 1,400 mW/cm²

Battery: Lithium ion

Features

- Low battery signal – visual and audible alarm
- Easy to read – LCD display
- High light intensity – 5 to 10 second cure
- No down time
- Flexibility – corded and cordless light cure
- Quiet fan – extends life of LED
- Sleep mode – conserves power, saves battery life
- Built-in radiometer

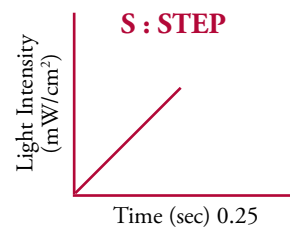
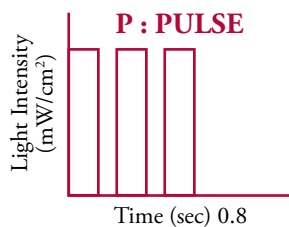
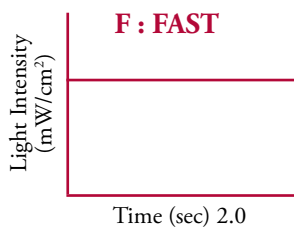

Standard Accessories

- LED 60 Handpiece
- Charging base
- 8mm light guide
- Eye protector
- Lithium ion battery
- Power supply
- User's Manual

Description

LED 60N Cordless Curing Light

Model

ALED-60N

Suggested Retail Price

\$490

Package includes the following:

LED 60N Cordless Curing Light

Charging Base

Protective Eye-shield

Countertop Stand with Power Indicator

8mm Light Guide

Built-in power radiometer

AC power supply



Options:

		Retail
P109-LG	Replacement light guide (8mm)	\$78.00
P219	Replacement protective eye-shield	\$10.00
ALED 60N-BATT	Replacement rechargeable battery for LED 60	\$60.00
P117	11mm light guide	\$105.00

Shipping Dimensions: 11"L x 8"W x 4"H / 3 lbs.
(10/cs.) 18"L x 12"W x 17"H / 24 lbs.

LED 55N

Cordless LED Curing Light



Specifications

- Battery: Lithium Ion, DC 3.6-4.2V
- Power adapter: 90-250V AC, 50-60 Hz
- Charging base: 9V DC
- Power consumption: 5 W LED
- Wavelength range: 430-490 nm
- Light Intensity: 1,250 mW / cm²
- Dimensions: 7"L x 1"W x 1"H
- Weight: 160 g
- Warranty: 2 year

Benefits

- Ergonomic, light weight design
- High intensity output up to 1 hour before recharging
- Cordless for ultimate convenience
- Cures most materials in 5-10 seconds
- Curing time: 20 seconds per cycle with beep every 10 seconds
- 2 Batteries included.

Charging Stand Light Indicators

LED color	Light Strength
Green	Normal
Orange	Light strength insufficient

Curing Status Light Indicators

LED color	Status Indication
Green	Normal
Red	Battery Voltage Low
Red Flashing	LED curing light handpiece is over temperature

Curing Mode Light Indicators

LED color	Working Mode
Green	Fast curing: Time setting 20 seconds (every 10 second, it sounds once)
Red	Pulse curing: interrupt radiating (every 10 seconds, it sounds once)
Orange	Step curing: soft start for 10 second from 0 to full power, then full power during the later 10 second



Charging Stand



ALED55N-1-G



ALED55N-1-R



ALED55N-1-B

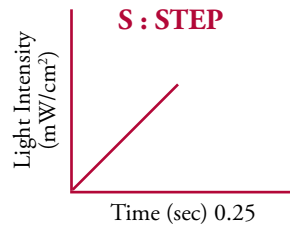
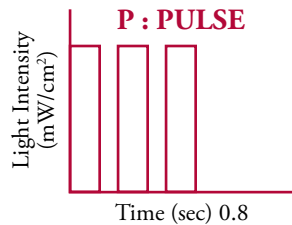
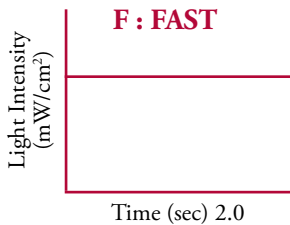

LM-300

Description

- LED 55N Cordless Curing Light Silver
- LED 55N Cordless Curing Light Blue
- LED 55N Cordless Curing Light Red

Model

- ALED55N-1-G Silver
- ALED55N-1-B Blue
- ALED55N-1-R Red

Suggested Retail Price

- \$470
- \$470
- \$470

Package includes the following:

- LED 55N Cordless Curing Light ✓
- Charging stand with power indicator ✓
- Protective Eye-Shield ✓
- AC Power Supply ✓

Options:

Options:		Retail
P109-LG	Replacement Light Guide for LED 55 (8mm)	\$78.00
ALED55N-BATT	Replacement Battery	\$80.00
P219	Replacement Protective Eye-shield	\$10.00
P117	11mm Light Guide	\$105.00
LM300	Curing Light Meter	\$150.00

Shipping Dimensions: 10"L x 7"W x 4"H / 3 lbs.
(10/cs.) 21"L x 11"W x 14"H / 24 lbs.

LED 55BN

Built-in Curing Light System



Specifications

- Wavelength range: 430-490 nm
- Light Intensity: 1,250 mW / cm²
- Warranty: 2 year
- Power consumption: 5 W LED

Model ALED55-BN



LM-300



Curing Mode Light Indicators

LED color	Working Mode
Green	Fast curing: Time setting 20 seconds (every 10 second, it sounds once)
Red	Pulse curing: interrupt radiating (every 10 seconds, it sounds once)
Orange	Step curing: soft start for 10 second from 0 to full power, then full power during the later 10 second

Curing Status Light Indicators

LED color	Status Indication
Green	Normal
Red Flashing	LED curing light handpiece is over temperature

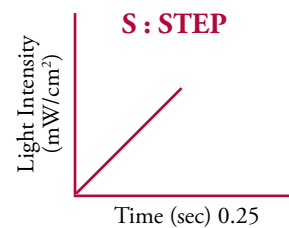
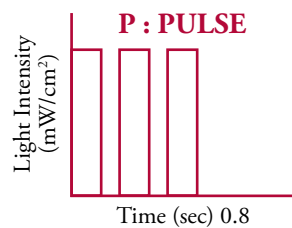
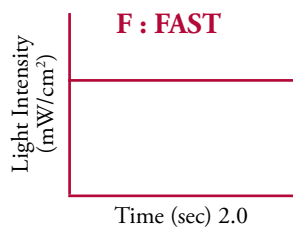

Description

Model

Suggested Retail Price

LED 55BN Built-in Curing Light (LED 5W installed in dental unit)	ALED55BN-A (110V - 240V)	\$390
LED 55BN Built-in Curing Light (LED 5W installed in dental unit)	ALED55BN-E (24V)	\$390

Package includes the following:

Turbo Light Guide	✓
Protective Eye-Shield	✓

Options:

		Retail
P109-LG	Replacement light guide for LED 55B	\$78.00
P219	Replacement protective eye-shield	\$10.00
LED 55BN-PS110	Replacement Power Supply 110V - 240V	\$60.00
LED 55BN-PS24	Replacement Power Supply 24V	\$60.00
P117	11mm Light Guide	\$105.00
LM300	Curing Light Meter	\$150.00

Shipping Dimensions: 10"L x 6"W x 2"H / 2 lbs.
(20/cs.) 21"L x 11"W x 12"H / 27 lbs.



LED 50N

Cordless Curing Light System

Specifications and Accessories

Switching Power Adapter

Power supply: AC 100-240V / 50-60 Hz
 Dimensions: 10"L x 2"W x 8"H

Hand Piece

Light source: 5W light emitting diode
 Wavelength: 430-490 nm
 Light Intensity: 800 - 1000 mW/cm²
 Battery: Lithium ion

Standard Accessories

- LED 50N Handpiece
- Charging base
- 8mm light guide
- Eye protector
- Lithium ion battery
- Power supply
- User's Manual



LM-300



Features

- Low battery signal – visual and audible alarm
- Easy to read – LCD display
- High light intensity – 5 to 10 second cure
- Flexibility – Cordless light cure
- Sleep mode – conserves power, saves battery life

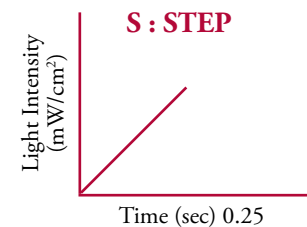
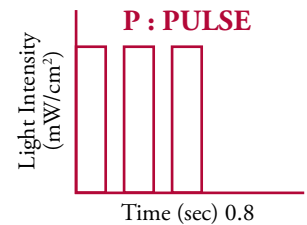
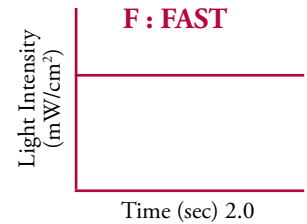

Description

LED 50 Cordless Curing Light

Package includes the following:

- LED 50 Cordless Curing Light
- Charging Base
- Protective Eye-shield
- Countertop Stand with Power Indicator
- 8mm Light Guide
- Built-in power transformer
- AC power supply

Model

ALED-50

Suggested Retail Price

\$390

Options:

		Retail
P109-LG	Replacement light guide (8mm)	\$78.00
P208	Replacement protective eye-shield	\$10.00
LED 50-BATT	Replacement rechargeable battery for LED 50	\$63.00
P117	11mm Light Guide	\$105.00
LM300	Curing Light Meter	\$150.00

Shipping Dimensions: 10"L x 8"W x 5"H / 2 lbs.
 (10/cs.) 24"L x 10"W x 16"H / 20 lbs.

LED 39N

Curing Light System



Specifications

- Class: Class II (ICE601-1)
- Wavelength range: 430-490 nm
- Light Intensity: 1,000 mW / cm²
- Warranty: 2 year

Standard Accessories

- LED 39 Handpiece
- Stand
- 8mm Light Guide
- Eye protector
- Power supply
- User Manual



Curing Mode Light Indicators

LED color	Working Mode
Green	Fast curing: Time setting 20 seconds (every 10 second, it sounds once)
Red	Pulse curing: interrupt radiating (every 10 seconds, it sounds once)
Orange	Step curing: soft start for 10 second from 0 to full power, then full power during the later 10 second

Curing Status Light Indicators

LED color	Status Indication
Green	Normal
Red Flashing	LED curing light handpiece is over temperature

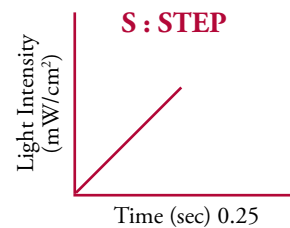
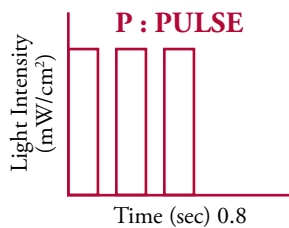
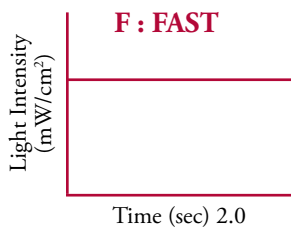

Description

LED 39N Curing Light
LED 39BN Curing Light

Model

ALED 39N
ALED 39BN (24V)

Suggested Retail Price

\$360
\$360

Package includes the following:

LED 39 Curing Light	✓
8mm Light Guide	✓
Protective Eye-Shield	✓
Stand	✓
Built-in Power Transformer	✓

Options:

		Retail
P109	Replacement light guide for LED 39N	\$78.00
P219	Replacement protective eye-shield	\$10.00
ALED 39N-PS	Replacement Power Supply	\$42.00

Shipping Dimensions: 13"L x 7"W x 3"H / 2 lbs.
(20/cs.) 24"L x 14"W x 14"H / 30 lbs.

Power Light 150

Halogen Curing Light



Specifications

- Output light intensity: 500-600 mW/cm²
- Output wavelength range: 400-500 nm
- Preset curing times from 10 to 60 seconds or continuous cure
- LCD digital display
- Maintains constant light output and curing strength
- 8 mm light guide, protective eye shield and instruction manual included
- Powerful 75 Watt bulb
- Ultra quiet fan
- 1 year warranty (bulb excluded)

Lighting Guides

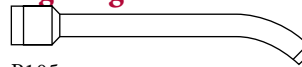

P105

8mm x 60°
for general curing

Description	Model	Suggested Retail Price
Power Light 150 Halogen Curing Light	PL-150	\$350
Package includes the following:		
Power Light 150 curing light	✓	
8mm x 60° curing tip	✓	
Protective eye-shield	✓	
1 Year warranty	✓	
Options:		Retail
P105	8mm x 60 degree curing tip for general curing	\$78.00
P201	Replacement bulb, 12V, 75W	\$29.00

Shipping Dimensions: 13"L x 9"W x 7"H / 6 lbs.
(5/cs.) 32"L x 14"W x 10"H / 30 lbs.

Power Light 100



Halogen Curing Light



Specifications

- Output light intensity: 500-600 mW/cm²
- Output wavelength range: 400-500 nm
- Preset curing times from 10 to 60 seconds or continuous cure
- LCD digital display
- Maintains constant light output and curing strength
- 8 mm light guide, protective eye shield and instruction manual included
- Powerful 75 Watt bulb
- Ultra quiet fan
- 1 year warranty (bulb excluded)

Lighting Guides

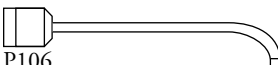
P101		13mm straight for large facial surface
P102		13mm x 80° for posterior occlusal curing
P103		8mm x 60° for general curing
P106		8mm - 3mm x 80° for layer curing of posterior restoration

Description	Model	Suggested Retail Price
Power Light 100 Halogen Curing Light	PL-100	\$399

Package includes the following:

Power Light 100 curing light	✓
8mm x 60° curing tip	✓
Protective eye-shield	✓
1 Year warranty	✓

Options:

		Retail
P101	13mm straight curing tip for large facial surface	\$105.00
P102	13mm x 80 degree curing tip for posterior occlusal curing	\$105.00
P103	8mm x 60 degree curing tip for general curing	\$78.00
P106	3mm x 90 degree curing tip for layer curing of posterior restoration	\$105.00
P201	Replacement bulb, 12V, 75W	\$29.00
P203	Protective eye shield for Power Light 100	\$17.00
L0005	Blue light filter + heat absorber (set).	\$42.00

Shipping Dimensions: 12"L x 9"W x 6"H / 6 lbs.
(4/cs.) 18"L x 13"W x 12"H / 26 lbs.

LM300

Curing Light Meter



Description

LED Light Meter

Model

LM-300

Suggested Retail Price

\$150

Package includes the following:

LED Light Meter



Battery



1 Year warranty



Shipping Dimensions: 8"L x 4"W x 2"H / 1 lbs.

Advance 850LED

LED Piezo Scaler w/Bottle System



A850-LED

Standard Scaler Features

- Compact unit housing for easy placement anywhere in the operatory
- Extremely gentle on patient, causes little or no sensitivity
- No heat build up in handpiece tip with extended use
- Autoclavable handpiece
- Extensive power range to allow widest choice of clinical applications includes General, Perio and Endo
- Fine water spray eliminates excessive overspray onto patient
- Bottle water or External water source
- 5 tips included with unit
- Endodontic file holder & files included
- Easy and rapid operating for root canal treatment
- Achieve enlargement of canal quickly
- 1 year warranty

Technical Data

- Absorbed Power: Max 15W
- Scaler: Max 10W, 24 -28kHz, automatic tuning
- Water Pressure: 30 - 145 PSI
- Water Consumption: 10 - 50 cc/min
- Approvals: ETL, according to UL - 2601 - 1
- Classification according to Medical Device
- Directive 93/42 EEC: Class 11a

Included tips



Endo file Holder



Description	Model	Suggested Retail Price
Advance 850-LED Piezo Ultrasonic Scaler & Endodontic Unit	A850-LED	\$820

Package includes the following:

Advance 850-LED piezo ultrasonic scaler with handpiece	✓
G1, G2, G4, P4, P5 tips	✓
Foot control	✓
Tip wrench	✓
Water Bottle	✓
Endo file holder + files	✓

Options:

	Retail
A760 Endo files and holder (21mm #25)	\$72.00
A761 Piezo scaler tip #G1	\$29.00
A762 Piezo scaler tip #G2	\$29.00
A763 Piezo scaler tip #P3 Slim	\$29.00
A767 Piezo scaler tip #G4	\$29.00
A764 Piezo scaler tip #P4	\$29.00
A766 Piezo scaler tip #P5	\$29.00
A746 Piezo scaler handpiece w/ LED	\$270.00
A776 Tip wrench	\$21.00
A749 Piezo scaler O-rings (5 pack)	\$8.40
A778 Replacement Water line	\$28.00
A775 Replacement scaler foot control	\$84.00

Shipping Dimensions: 18"L x 14"W x 5"H / 6 lbs.
(4/cs.) 18"L x 15"W x 21"H / 26 lbs.

Advance 750LED

LED Piezo Scaler

Standard Scaler Features

- Compact unit housing for easy placement anywhere in the operatory
- intense LED Light Source
- Extremely gentle on patient, causes little or no sensitivity
- No heat build up in handpiece tip with extended use
- Autoclavable handpiece
- Extensive power range to allow widest choice of clinical applications
- Fine water spray eliminates excessive overspray onto patient
- Thin subgingival tips available
- 5 tips included with unit

Optional Endodontics Unit Features

- Endodontic file holder
- Easy and rapid operating for root canal treatment
- Achieve enlargement of canal quickly



Specifications

- Input rating: 115/230V, 50/60 Hz
- Dimensions: 160mm(W) x 155mm(D) x 70mm(H)
- Weight: 2.1 kg
- Frequency: 32 KHz
- Water pressure: 1-4 kg/cm²
- Fuses: 230V, 2 per unit ; F0.5A 250V-CQ-S500
- Fuses: 110V, 1 per unit ; F1A 5A 250V-CQ-S500
- 3 tips included with unit
- 1 year warranty (tips excluded)

Description	Model	Suggested Retail Price
Advance 750N Piezo Ultrasonic Scaler & Endodontic Unit	A750N	\$560
Advance 750N Piezo Ultrasonic Scaler & Endodontic Unit W/LED	A750LED	\$640

Package includes the following:

Advance 750N piezo ultrasonic scaler with handpiece	✓	
#G1, #G2, #G3, #P4, #P5 tip	✓	✓
Foot control	✓	✓
Tip wrench	✓	✓
Advance 750 LED handpiece		✓

Options:	Retail
A760 Endo files and holder (21mm #25)	\$72.00
A761 Piezo scaler tip #G1	\$29.00
A762 Piezo scaler tip #G2	\$29.00
A763 Piezo scaler tip #P3 (slim)	\$29.00
A764 Piezo scaler tip #P4	\$29.00
A766 Piezo scaler tip #P5	\$29.00
A767 Piezo scaler tip #G4	\$29.00
A745 Piezo scaler handpiece	\$190.00
A746 Piezo scaler handpiece w/LED	\$270.00
A776 Tip wrench	\$21.00
A749 Piezo scaler O-rings (5 pack)	\$8.40
A778 Replacement Water line	\$28.00
A775 Replacement scaler foot control	\$84.00

Shipping Dimensions: 13"L x 10"W x 5"H / 5 lbs.
(8/cs.) 21"L x 14"W x 18"H / 42 lbs.

Advance 800N

Piezo Ultrasonic Built-In Scaler

A800N



A800LED



Features

- Extremely gentle on patient, causes little or no sensitivity
- No heat build up in handpiece tip with extended use
- Autoclavable handpiece
- Extensive power range to allow widest choice of clinical application
- Fine water spray eliminates excessive overspray onto patient
- Thin subgingival tips available
- 5 tips included with unit
- 1 year warranty (tips excluded)

Additional Benefits

- The Advance 800N eliminates the need for external water line and power cord connections
- The Advance 800N operates from unit foot control - no additional foot control needed
- The Advance 800N allows for a clean appearing operatory eliminating all visible tubes and power lines.

Specifications

- Transformer: 24V, 1 amp
- Activated by unit foot control – no additional foot control needed
- Small electronic box, 2-3/8"L x 1.5"W x 1.25"H
- Easy tip system allows tips to be changed easily
- Absorbed power: max 15 watt
- Scaler: max 10 watt, 24-28 kHz, automatic tuning
- Water pressure: 30-145 PSI
- Water consumption: 10-50 cc/min
- No external water line / power cord
- 1 year warranty (tips excluded)

Description	Model	Suggested Retail Price
Advance 800N Piezo Ultrasonic Built In Scaler	A800N	\$490
Advance 800N Piezo Ultrasonic Built In Scaler W/LED	A800LED	\$570

Package includes the following:

Advance 800N piezo ultrasonic scaler with handpiece	✓	
#G1, #G2, #G4, #P4, #P5 tip	✓	✓
Tip wrench	✓	✓
Transformer	✓	✓
Control box	✓	✓
Advance 800 LED handpiece		✓

Options:	Retail
A760 Endo files and holder (21mm #25)	\$72.00
A761 Piezo scaler tip #G1	\$29.00
A762 Piezo scaler tip #G2	\$29.00
A763 Piezo scaler tip #P3 (slim)	\$29.00
A764 Piezo scaler tip #P4	\$29.00
A766 Piezo scaler tip #P5	\$29.00
A767 Piezo scaler tip #G4	\$29.00
A745 Piezo scaler handpiece	\$190.00
A746 Piezo scaler handpiece w/LED	\$270.00
A776 Tip wrench	\$21.00
A749 Piezo Scaler O-rings (5 pack)	\$8.40

Shipping Dimensions: 9"L x 7"W x 4"H / 4 lbs.
(10/cs.) 14"L x 10"W x 18"H / 40 lbs.

PowerMAX25

Ultrasonic Scaling System

Model PM25



Features

- Available in 25Khz
- Precision automatic tuning circuitry
- Linear power control for exact power setting
- Accepts Cavitron®, P, SLI, TFI, and FSI scaler inserts
- Compact and lightweight
- Auto-ranging 110-240 VAC input
- Includes one ultrasonic scaler insert and foot control
- 1 year warranty

Specifications

Weight: 6 lbs
 Dimensions: 8"(W) x 8"(D) x 3"(H)
 Output power to tip: Operator adjust approximately 10-40 watts
 Handpiece cable: 7.5'
 Power supply to unit: 110-240 VAC Input, 50/60 Hz
 Water flow and supply pressure: 18 cc to 30 cc per minute flow from insert tip
 Supply pressure to scaler is 25-60 PSIG city water or bottle system

Description	Model	Suggested Retail Price
PowerMAX25 Ultrasonic Scaler with insert	PM25	\$690

Package includes the following:

PowerMAX ultrasonic scaler	✓
25K universal scaler insert	✓
Foot control	✓
1 year warranty	✓

Options:

		Retail
S1025	25K universal insert-external water flow	\$70.00
S1030	30K universal insert- external water flow	\$70.00
S2025	25K universal slim insert- external water flow	\$70.00
S2030	30K universal slim insert- external water flow	\$70.00
S3025	25K universal insert- plastic handle- internal water flow	\$70.00
S3030	30K universal insert- plastic handle- internal water flow	\$70.00
S4025	25K universal slim insert- plastic handle- internal water flow	\$70.00
S4030	30K universal slim insert- plastic handle- internal water flow	\$70.00
S8001	25K Replacement handpiece w/ Tubing	\$100.00
PM775	Power Max replacement foot control	\$76.00
A778	Replacement water line 6' long with male quick disconnect (with shut off)	\$28.00

Shipping Dimensions: 12"L x 12"W x 4"H / 8 lbs.
 (5/cs.) 18"L x 13"W x 14"H / 38 lbs.

Ultrasonic Scaler Inserts



#S1025
25K Universal Scaler Insert
(metal handle)

#S1030
30K Universal Scaler Insert
(metal handle)

Features

- External water
- Interchangeable for use with other brands of scalers
- 90 day warranty against defects arising from faulty materials or workmanship



#S2025
25K Universal Slim Scaler Insert
(metal handle)

#S2030
30K Universal Slim Scaler Insert
(metal handle)

Features

- Slim tip design
- External water
- Interchangeable for use with other brands of scalers
- 90 day warranty against defects arising from faulty materials or workmanship



#S3025
25K Universal Scaler Insert
(plastic handle)

#S3030
30K Universal Scaler Insert
(plastic handle)

Features

- Internal water delivery system delivers water directly to the insert tip and focuses it where it is needed most
- Large, round, non-slip plastic grip for greater tactile sensitivity, rotational control and reduced hand fatigue
- Better water management and less water usage means greater patient comfort
- Interchangeable for use with other brands of scalers
- 90 day warranty against defects arising from faulty materials or workmanship



#S4025
25K Universal Slim Scaler Insert
(plastic handle)

#S4030
30K Universal Slim Scaler Insert
(plastic handle)

Features

- Internal water delivery system delivers water directly to the insert tip and focuses it where it is needed most
- Large, round, non-slip plastic grip for greater tactile sensitivity, rotational control and reduced hand fatigue
- Better water management and less water usage means greater patient comfort
- Interchangeable for use with other brands of scalers
- 90 day warranty against defects arising from faulty materials or workmanship

Model	Description	Retail
S1025	25K universal insert-external water flow	\$70.00
S1030	30K universal insert- external water flow	\$70.00
S2025	25K universal slim insert- external water flow	\$70.00
S2030	30K universal slim insert- external water flow	\$70.00
S3025	25K universal insert- plastic handle- internal water flow	\$70.00
S3030	30K universal insert- plastic handle- internal water flow	\$70.00
S4025	25K universal slim insert- plastic handle- internal water flow	\$70.00
S4030	30K universal slim insert- plastic handle- internal water flow	\$70.00
S8003	Ultrasonic Scaler insert O-rings (5 pack)	\$10.00

Shipping Dimensions: 9"L x 2"W x 1"H / 1 lbs.

AS 5000

Sonic Air Scaler



Features

- Includes 3 tips AS1, AS2, AS3.
- Tip wrench included.
- Light weight
- Portable
- Saves time
- Autoclaveable
- Available in 2 or 4 hole.

Description	Model	Suggested Retail Price
Air Sonic Scaler -4 Hole Kit	AS5000-M4	\$270
Air Sonic Scaler -2 Hole Kit	AS5000-B2	\$270

Package includes the following:

AS5000 Air sonic scaler handpiece	✓	✓
AS1 Universal Tip	✓	✓
AS2 Sickle Tip	✓	✓
AS3 Perio Tip	✓	✓
A776 Tip Wrench	✓	✓
6 Month warranty		

Options:

	Retail
AS1 Universal Tip	\$24.00
AS2 Sickle Tip	\$24.00
AS3 Perio Tip	\$24.00

Shipping Dimensions: 9"L x 4"W x 2"H / 1 lbs.

Air Polishing System

Polishing System

EZ Nozzle

- Carefully designed length, angle and curve of nozzle for applications to both anterior and posterior teeth. Allows for accurate direction of the power jet
- Includes two prophy nozzles
- Handpiece nozzle is fully autoclavable up to 134 °C / 273 °F

Ergo Comfort Design

- Fits comfortably in large and small hands. Notched grip allows firm and accurate tip control

Lightweight & Flexible

No Installation Cost

- Simply connects to handpiece tubing
- No extra foot control needed
- No external air or water connections needed

Cleaning Power

- Jet Polishing powder (130g) has a refreshing lemon scent

Powder Holder Covers

- Three translucent color coded holder covers are included (blue, green, purple)

Quick Connection

- Simply pull back the quick release ring to release the nozzle from the handpiece



P560

Description	Model	Suggested Retail Price
Air Polishing System	P555-4H	\$240
Air Polishing System	P557-4H	\$280

Package includes the following:

- | | | |
|---|---|---|
| 1 – 130g of prophy powder | ✓ | ✓ |
| 3 – color coded (red, blue, green) powder holder covers | ✓ | ✓ |
| 2 – nozzles (360 degree swivel) | ✓ | ✓ |
| 1 – cleaning tool | ✓ | ✓ |
| 1 – O-ring set | ✓ | ✓ |
| 1 year warranty | ✓ | ✓ |

Options:

	Retail
P560 130g of prophy powder	\$14.00
P660 Nozzle for P555	\$50.00
P665 Nozzle for P557	\$60.00

Shipping Dimensions: 9"L x 8"W x 3"H / 2 lbs.
(10/cs.) 13"L x 13"W x 10"H / 12 lbs.

Ultrasonic Cleaner

Dentsonic UC 400 / 1000



Model UC-400

Features

- Powerful 40 KHz of cavitation for thorough, quieter cleaning
- Stainless steel cover and tank with welded drain
- Durable vinyl clad steel housing is scratch resistant and easy to clean
- Digital timer for quick and easy process
- Sweep technology ensures exceptional cleaning efficiency
- 1 year warranty
- 2 tank sizes available 3.8 qt / 10.6qt
- Includes basket and lid

MODEL	UC-400	UC-1000
Input 115V	✗	✓
Input 230V	✓	✓
Frequency	50/60 Hz	50/60 Hz
Overall Dimensions L x W x H	10.6" x 6.3" x 9.5" 27cm x 16cm x 24cm	14.2" x 10.6" x 12.2" 36cm x 27cm x 31cm
Tank Internal Dimensions L x W x H	9.5" x 5.5" x 4" 24cm x 14cm x 10cm	11.8" x 9.5" x 5.9" 30cm x 24cm x 15cm
Ship Weight	10 lbs. 4.5 Kg	19 lbs. 8.6 Kg
Tank Capacity	3.8 Qts. / .95 Gallon 3.59 Liter	10.6 Qts. / 2.65 Gallon 10 Liter
Timer	LCD Display 1-99 minutes	LCD Display 1-99 minutes
302 StainlessSteel	✓	✓

UC-400 14 "L x 11"W x 3"H / 11 lbs.
UC-1000 17 "L x 15"W x 16"H / 21 lbs.

Description	Model	Retail Price
UC-400 Ultrasonic Cleaner (3.8 qt.)	UC-400	\$570
UC-1000 Ultrasonic Cleaner (10.6 qt)	UC-1000	\$1080

Package includes the following:

Ultrasonic cleaner	✓	✓
Stainless steel basket	✓	✓
Stainless steel lid	✓	✓
Drain kit	✓	✓
Timer	✓	✓

Options		Retail Price
UC400-BASKET	Replacement Basket (3.8 qt.)	\$72.00
UC1000-BASKET	Replacement Basket (10.6 qt)	\$115.00

Dentsonic

Ultrasonic Cleaner

Features

- Powerful 35 KHz of cavitation for thorough, quieter cleaning
- Stainless steel tank
- Durable plastic housing is scratch resistant and easy to clean
- Digital timer for quick and easy process
- Sweep technology ensures exceptional cleaning efficiency
- 2 tank sizes available 2.5qt., 3.0qt.
- Includes basket and lid
- 1 year warranty



UC-250



UC-300



Shipping Dimensions

UC-250	14"L x 11"W x 10"H / 8 lbs. (4/cs) 23L x 15W x 20H / 35lbs.
UC-300	20"L x 14"W x 12"H / 16 lbs. (2/cs) 20"L x 14"W x 24"H / 34Lbs

Model	UC-250	UC-300
Input 115Vac	✓	✓
Input 220Vac	✓	✓
Frequency	50/60 Hz	50/60 Hz
Overall dimensions	12.6" x 9.6" x 8.0"	17.5" x 10.8" x 8.1"
Tank Internal Dimensions	9.8" x 6.0" x 3.0"	9.8" x 7.0" x 3.0"
Shipping Weight	8 lbs	13 lbs
Tank Capacity	2.5 qt, 0.65 Gal, 2.46 L	3.0 qt, 0.8 Gal, 3.028 L
Digital Timer	LCD Display 1-30 min	LCD Display 1-30 min
302 Stainless Steel Tank	✓	✓

Description

UC-250 Ultrasonic Cleaner 2.5 Qt
UC-300 Ultrasonic Cleaner 3.0 Qt

UC-250

Model

UC-300-S

Suggested Retail Price

\$250

\$350

Package includes the following:

Ultrasonic cleaner	✓	✓
Basket	✓	✓
lid	✓	✓
Drain kit	✓	✓
Digital timer	✓	✓
Heater	✓	✓

Dentsonic

Ultrasonic Cleaner

Features

- Powerful 35 KHz of cavitation for thorough, quieter cleaning
- Stainless steel tank
- Durable plastic housing is scratch resistant and easy to clean
- Digital timer for quick and easy process
- Sweep technology ensures exceptional cleaning efficiency
- 2 tank sizes available
 - 1.6 Gallon
 - 2.0 Gallon
- Includes basket and lid
- 1 year warranty

UC-600



Shipping Dimensions

UC-600 23 "L x 16"W x 14 "H / 23 lbs.
 UC-750 24 "L x 16"W x 14"H / 27lbs.



UC-750

Model	UC-600	UC-750
Input 115Vac	✓	✓
Input 220Vac	✓	✓
Frequency	50/60 Hz	50/60 Hz
Overall dimensions	21.0" x 12.0" x 9.6"	21.3" x 13.3" x 10.9"
Tank Internal Dimensions	13" x 8.0" x 4.0"	13" x 9.4" x 4.1"
Shipping Weight	20 lbs	25 lbs
Tank Capacity	6.4 qt, 1.6 Gal, 6.056 L	8 qt, 2 Gal, 7.5 L
Digital Timer	LCD Display 1-30 min	LCD Display 1-30 min
302 Stainless Steel Tank	✓	✓

Description

UC-600 Ultrasonic Cleaner 1.6 Gallon
 UC-750 Ultrasonic Cleaner 2.0 Gallon

UC-600-S

Model

UC-750

Suggested Retail Price

\$600

\$798

Package includes the following:

Ultrasonic cleaner	✓	✓
Basket	✓	✓
lid	✓	✓
Drain kit		✓
Digital timer	✓	✓
Heater	✓	✓

TPC Dentsonic Ultrasonic Cleaner

Cassette Cross reference

851 South Lawson Street City of Industry CA 91748 • tpcdental.com • 800-560-8222

	UC-250	UC-300	UC-400	UC-600	UC-750	UC-1000
Tank Size (L x W x H)	9.6" x 5.9" x 3.0"	9.8" x 6.9" x 3.1"	9.5" x 5.5" x 4"	12.7" x 8.1" x 3.9"	12.5" x 9" x 3.5"	11.8" x 9.5" x 5.9"

Hu-Friedy						
Large Cassette 16-Instruments 8" x 11" x 1.25"				✓	✓	
Large Cassette 20-Instruments 4.5" x 8" x 1"			✓	✓	✓	✓
Small Cassette 8-Instruments 5.5" x 8" x 1.25"	✓	✓	✓	✓	✓	✓
Small Cassette 10-Instruments 5.5" x 8" x 1.25"	✓	✓	✓	✓	✓	✓
Exam Cassette 5-Instrument 3" x 8" x 1.25"	✓	✓	✓	✓	✓	✓
Space Saver 7-Instrument 4.5" x 8" x 1"	✓	✓	✓	✓	✓	✓
Double Decker Cassette 8-Inst. 3" x 8" x 1.5"	✓	✓	✓	✓	✓	✓
Double Decker Cassette 14-Inst. 4.5" x 8" x 1.5"	✓	✓	✓	✓	✓	✓
Double Decker Cassette 20-Inst. 6" x 9.7" x 1.5"		✓	✓	✓	✓	✓
Signa Stat Cassette 12-Inst. 6.5" x 10.5" x 1.25"				✓	✓	✓
Oral Surgery Cassette 12-Inst. 8" x 14.5" x 1.25"						
Radiography Cassette 4.5" x 8" x 1.5"		✓	✓	✓	✓	✓
Handpiece Cassette 3" x 8" x 1.25"	✓	✓	✓	✓	✓	✓
Ultrasonic Insert Cassette 1.5" x 8" x 1.25"	✓	✓	✓	✓	✓	✓

Zirc						
E-Z Jett Cassette 10-Place 7.93" x 7" x 1.125"				✓	✓	✓
E-Z Jett Cassette 8-Place 7.93" x 4.4375" x 1.125"	✓	✓	✓	✓	✓	✓
E-Z Jett Cassette 5-Place 8" x 3.125" x 1.1875"		✓	✓	✓	✓	✓
Compact Cassette 7.125" x 3.875" x 0.625"		✓	✓	✓	✓	✓
Mini Matt 3.875" x 3.5" x .5"	✓	✓	✓	✓	✓	✓
Instrument Mat 6.75" x 2" x 0.375"	✓	✓	✓	✓	✓	✓
Standard Steri-Container 8.125" x 1.875" x 1.875"	✓	✓	✓	✓	✓	✓
Compact Steri-Container 7.125" x 1.5" x 1.5"	✓	✓	✓	✓	✓	✓

Warning: There should absolutely be NO metal-metal contact inside of the tank during ultrasonic cycle
This includes No direct: Loose Instrument-to-Instrument, Cassette-to-Tank, Cassette-to-Cassette, Cassette-to-Basket; metal contact. Make sure Cassettes have standard silicone insulations and feet; if no basket is used.
 Tank Dimensions are measured without baskets; basket sizes vary depending on unit.
 Please contact your cassette manufacturer or TPC if you have any questions.

D650N

Digital Amalgamator

Model D-650N



Features

- ISO 9002 / ISO 13488 quality management certified
- Input voltage: 110V or 230V
- Touch pad selector
- Pre-programmed time settings
- Quiet, high-speed mix capsules
- Built-in automatic timer
- Accepts all capsules
- Customized trituration times
- Vibration frequency $\geq 4,400$ RPMs
- 1 year warranty

Description

D650 Digital Amalgamator

Model

D-650N

Suggested Retail Price

\$380

Package includes the following:

D650 digital amalgamator

✓

AC power cord

✓

Shipping Dimensions: 13"L x 10"W x 10"H / 10 lbs.
(2/cs.) 20"L x 14"W x 10"H / 20 lbs.

N7

Micromotor and Handpiece



Features

- Powerful torque and variable speed motor
- No heat after long hours of operation
- Easy change of driving direction for efficiency
- Variable speed foot control
- Compact and ergonomic design
- Automatic stop with alarm beep and overload reset
- Includes control unit, motor handpiece and foot pedal
- 0–35,000 RPMs
- 110/220V ; 50/60Hz, 0.7A
- 1 year warranty

Description	Model	Suggested Retail Price
TPC Marathon N7 Micromotor and Handpiece	MM7	\$550
TPC Marathon N2 Micromotor and Handpiece	MM2	\$470

Package includes the following:

N7 micromotor and handpiece	✓
AC power cord	✓
Foot pedal	✓

Options:

		Retail
MM7-HP	Handpiece only with cable	\$330.00
MM7-MOTOR	Motor Control Box	\$330.00
MM7-VFC	Replacement Foot control	\$64.00
MM7-BR	Replacement Carbon Brushes	\$15.00

Shipping Dimensions: 11"L x 11"W x 5"H / 7 lbs.
(8/cs.) 24"L x 12"W x 21"H / 58 lbs.

Disposable Micro Applicators



M6500-XSL
(Black)

• Four individual dispenser tubes included with each box

• 36 Boxes/case

Part No.	Description	Retail	1 Case	3+ Case
M6500-R	Disposable Micro Applicators, 400 ct. (Green / Orange)	\$17.50/Box	\$12.00/Box	\$10.00/Box
M6500-F	Disposable Micro Applicators, 400 ct. (Yellow / Blue)	\$17.50/Box	\$12.00/Box	\$10.00/Box
M6500-SF	Disposable Micro Applicators, 400 ct. (White / Purple)	\$17.50/Box	\$12.00/Box	\$10.00/Box
M6500-XSL	Disposable Micro Applicators, 400 ct. (Black)	\$17.50/Box	\$12.00/Box	\$10.00/Box

Package includes the following:

Four dispenser tubes, 100 brushes per tube

Features

- Non- linting fibers
- Bendable stiff tip
- Dispensing tubes eliminate the potential for cross contamination.

Shipping Dimensions: 4"L x 4"W x 5"H / 1 lbs.
(36/cs.) 17"L x 13"W x 15"H / 35 lbs.

Disposable Syringe Tips

Description

P7700 Disposable White Syringe Tip
 P7700-Bulk-refill (1600 pcs) Does not include dispenser

- Metal Interior
- 250 tips / box
- Syringe tip dispensers included (125 tips per dispenser)
- 36 boxes per case



Retail

\$40.00/ box
 \$192.00

1 Case

\$30.00/box

3+ Case

\$24.00/ box

Features

- No adapter required fits most syringes (Unless converting from proprietary tip adapter)
- Interchangeable with metal syringe tip
- Available in a variety of bright colors
- Dispensing container reduces the risk of cross contamination

Shipping Dimensions: 6"L x 3"W x 4"H / 2 lbs.
 36/cs 18"L x 13"W x 14"H / 48 lbs.
 Bulk refill 40/cs 18"L x 10"W x 9"H / 33 lbs.

Description

P7705 Disposable White Syringe Tip
 P7705-Bulk-refill (1600 pcs) Does not include dispenser

- Plastic Interior
- 250 tips / box
- Syringe tip dispensers included (125 tips per dispenser)
- 36 boxes per case



Retail

\$30.00/ box
 \$140.00

1 Case

\$22.00/box

3+ Case

\$16.00/ box

Features

- No adapter required fits most syringes (Unless converting from proprietary tip adapter)
- Interchangeable with metal syringe tip
- Available in a variety of bright colors
- Dispensing container reduces the risk of cross contamination

Shipping Dimensions: 6"L x 3"W x 4"H / 1 lbs.
 36/cs 18"L x 13"W x 14"H / 32 lbs.
 Bulk refill 40/cs 18"L x 10"W x 9"H / 18 lbs.

Description

P7725 Rainbow Syringe Tip
 P7725-Bulk-refill (1600 pcs) Does not include dispenser

- Rainbow colored interior tip
- 250 tips / box
- 2 Syringe tip dispensers included (125 tips per dispenser)
- 36 boxes per case



Retail

\$30.00/ box
 \$140.00

1 Case

\$22.00/box

3+ Case

\$16.00/ box

Features

- No adapter required fits most syringes (Unless converting from proprietary tip adapter)
- Interchangeable with metal syringe tip
- Available in a variety of bright colors
- Dispensing container reduces the risk of cross contamination

Shipping Dimensions: 6"L x 3"W x 4"H / 1 lbs.
 36/cs 18"L x 13"W x 14"H / 32 lbs.
 Bulk refill 40/cs 18"L x 10"W x 9"H / 18 lbs.

Disposable Prophylaxis Angles



(Purple Color / Soft Cup)

(Blue Color / Firm Cup)

- Latex free
- Individually packaged

- 20 Boxes/case PA144
- 8 Boxes/case PA500

Shipping Dimensions, Qty. **500:** 13"L x 11"W x 8"H / 4 lbs.
(8/cs.) 22"L x 14"W x 32"H / 36 lbs.

Shipping Dimensions, Qty. **144:** 10"L x 7"W x 6"H / 1 lbs.
(20/cs.) 20"L x 14"W x 29"H / 29 lbs.

Part No.	Description	Retail	1 Case	3+ Case
PA144-F	Disposable prophylaxis angles, 144 ct., Firm	\$58.00/Box	\$49.00/Box	\$45.00/Box
PA500-F	Disposable prophylaxis angles, 500 ct., Firm	\$188.00/Box	\$170.00/Box	\$150.00/Box
PA144-S	Disposable prophylaxis angles, 144 ct., Soft	\$58.00/Box	\$49.00/Box	\$45.00/Box
PA500-S	Disposable prophylaxis angles, 500 ct., Soft	\$188.00/Box	\$170.00/Box	\$150.00/Box

Disposable Evacuator Tips



SAT-SW
Small (25 tips / bag) White

Shipping Dimensions: 11"L x 7"W x 9"H / 5 lbs.
(160/cs)23"L x 15"W x 18"H / 37 lbs.



SAT-LG
Large (25 tips / Bag) Green

Shipping Dimensions: 11"L x 7"W x 9"H / 6 lbs.
(160/cs)23"L x 15"W x 18"H / 46 lbs.

Part No.	Description	1 Box (20 Bags)	8 Box (160 Bags)
SAT-SW	Small Surgical Aspirator Tip (1/8") White	\$58.00	\$52.00
SAT-LG	Large Surgical Aspirator Tip (1/4") Green	\$66.00	\$60.00

Minimum Order 1 box



HVE-1000
(100 tips / bag) x 10 Bags

Shipping Dimensions: 12"L x 10"W x 10"H / 8 lbs.
(40 bag/cs)20"L x 13"W x 21"H / 32 lbs.

Part No.	Description	1 box	+20 box
HVE-1000	High Volume Combo Tip (10 bags / box)	\$35.00/box	\$32.00/box

Lab Products



2" Crown Box



1" Crown Box



Honey Comb Tray
W/ Metal Pin



Honey Comb Tray
W/ Ceramic Pin



Dowl Pin



Disposable Articulators
Black



Disposable Articulators
White

Part No.	Description	Retail
LAB-CRWBX-2	Plastic Crown Box W/ 2" Foam 500 / cs (Blue)	\$148.00
LAB-CRWBX-2BLK	Plastic Crown Box W/ 2" Foam 500 / cs (Black)	\$148.00
LAB-CRWBX-1	Plastic Crown Box W/ 1" Foam 1000 / cs (Blue)	\$182.50
LAB-CRWBX-1BLK	Plastic Crown Box W/ 1" Foam 1000 / cs (Black)	\$182.50
LAB-HC-MP	Honey Comb Tray W/ Metal Pin	\$11.30
LAB-HC-CP	Honey Comb Tray W/ Ceramic Pin	\$13.50
LAB-DP-M	Medium Dowl Pin 1000 / Bx	\$29.00
LAB-DART-WH	Disposable Articulators White 100 / Bag	\$17.50
LAB-DART-BLK	Disposable Articulators Black 100 / Bag	\$15.50

Disposable Prophy Cups & Brushes



Description			Model	Retail
Latch type prophy brush	flat / white	pkg of 144	PB-300	\$38.00
Latch type prophy brush	flat / black	pkg of 144	PB-310	\$40.00
Screw-on type prophy brush	flat / white	pkg of 144	PB-320	\$36.00
Screw-on type prophy brush	pointed / white	pkg of 144	PB-330	\$36.00
Latch type prophy brush	pointed / white	pkg of 144	PB-340	\$38.00
Latch type prophy brush	pointed / black	pkg of 144	PB-350	\$40.00
Latch type prophy brush	cup shade / white	pkg of 100	PB-360	\$38.00
Latch type prophy brush	cup shade / bristle	pkg of 100	PB-370	\$42.00
Latch type prophy cup	webbed / white	pkg of 144	PC-505	\$22.00
Screw-on type prophy cup	webbed / white	pkg of 144	PC-515	\$25.00
Pointed-on prophy cup	webbed / white	pkg of 144	PC-525	\$25.00
Snap-on prophy cup	webbed / white	pkg of 144	PC-535	\$12.00

Shipping Dimensions: 4"L x 3"W x 2"H 1lbs.

Alligator X-ray Film Holder - Straight

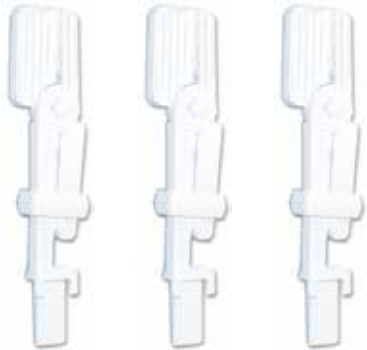

Part No.	Description	Retail
M7000-S	Alligator film holder (straight)	\$10.80

- Straight
- Box of 3

Post Mount Utility Tray

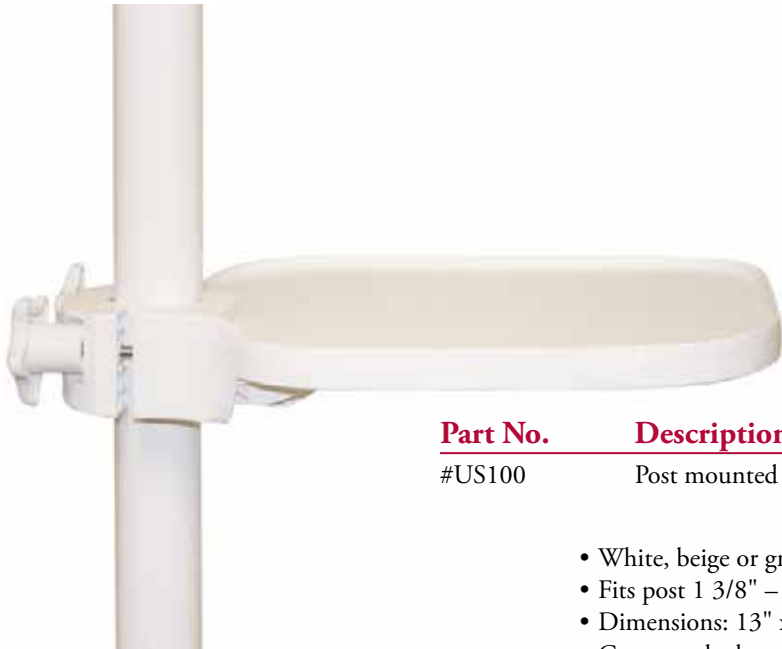

Part No.	Description	Retail	1 Case
#US100	Post mounted utility tray (specify color)	\$60.00	\$50.00

- White, beige or grey
- Fits post 1 3/8" – 2 1/2"
- Dimensions: 13" x 10"
- Contoured edge to contain spills and materials

• 20 Trays/Case

Shipping Dimensions: 17"L x 10"W x 3"H / 2 lbs.
 (20/cs.) 25"L x 22"W x 18"H / 38 lbs.

FILM MOUNTS

Clear Pocket Mounts

Buy 3, Get 1 FREE!

Same Style Only

The ultimate in film protection, with clear pockets that hold all sizes, with full visibility.

All packages include 100 mounts each. All mounts are Buy 3, Get 1 FREE!

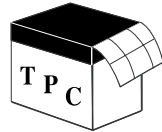

	Catalogue #	Description	Retail Price
	CP102U	Universal Select and Cut Roll of 500 Stripes of 2 mounts (1000 Windows)	\$ 43.00
	CP1C	One Window Convertible	\$ 12.50
	CP2H	Two Window Horizontal	\$ 14.00
	CP4C	Four Window Convertible	\$ 19.00
	CP4H	Four Window Horizontal	\$ 19.00
	CP6H	Six Window Horizontal	\$ 20.50
	CP4H2V	Six Window - 4 Horizontal - 2 Vertical	\$ 21.50
	CP8C	Eight Window Convertible	\$ 25.50
	CP8P	Eight Window Pedo 2H #2 6H#0	\$ 27.00
	CP10C	Ten Window Convertible	\$ 30.00
	CP8H6V	Fourteen Window - 8 Horizontal - 6 Vertical	\$ 35.00
	CP12H6V	Eighteen Window - 12 Horizontal - 6 Vertical	\$ 40.00
	CPTAG	Name Tag 100 / Pkg	\$ 6.00













FILM MOUNTS

Open Window Mounts

Buy 2, Get 1 FREE!
Same Style Only

Ten window film mounts provide excellent contrast for viewing.
Safely store radiographs and films. Easy loading.

All packages include 100 mounts each. Open window mounts are Buy 2, Get 1 FREE!

	Catalogue #	Description	Retail Price
	W1H2	One Window Horizontal #2 Film	\$ 12.00
	W2H0	Two Window Horizontal #0 Film	\$ 13.00
	W2H2	Two Window Horizontal #2 Film	\$ 13.00
	W2H3	Two Window Horizontal #3 Film	\$ 13.60
	W4H0	Four Window Horizontal #0 Film	\$ 18.50
	W4H2	Four Window Horizontal #2 Film	\$ 18.50
	W4H2V2	Six Window - 4 Horizontal - 2 Vertical #2 Film	\$ 22.00
	W6H2	Six Window Horizontal #2 Film	\$ 22.00
	W8H2	Eight Window Horizontal #2 Film	\$ 27.00
	W8H6V2	Fourteen Window - 8 Horizontal - 6 Vertical #2 Film	\$ 34.00
	W12H6V2	Eighteen Window - 8 Horizontal - 6 Vertical - 4 BW #2 Film	\$ 44.00
	W10BW2	Ten Window BW #2 Film	\$ 33.00
	W20BW2	Twenty Window History Mount #2 Film	\$ 56.00

FILM MOUNTS













Notched Mounts

Buy 2, Get 1 FREE!

Same Style Only

Easy opening die cuts hold the film secure, while its thin profile requires minimum filing space. They are translucent for easy viewing.

All packages include 100 mounts each. Notched mounts are Buy 2, Get 1 FREE!

	Catalogue #	Description	Retail Price
	N1H2	One Window Horizontal #2 Film	\$ 11.20
	N2H0	Two Window Horizontal #0 Film	\$ 12.00
	N2H2	Two Window Horizontal #2 Film	\$ 12.00
	N2H3	Two Window Horizontal #3 Film	\$ 13.00
	N4H0	Four Window Horizontal #0 Film	\$ 17.00
	N4H2	Four Window Horizontal #2 Film	\$ 17.00
	N4H2V2	Six Window - 4 Horizontal - 2 Vertical #2 Film	\$ 21.00
	N6H2	Six Window Horizontal #2 Film	\$ 21.00
	N8H2	Eight Window Horizontal #2 Film	\$ 27.50
	N8H6V2	Fourteen Window - 8 Horizontal - 6 Vertical #2 Film	\$ 34.00
	N12H6V2	Eighteen Window - 8 Horizontal - 6 Vertical - 4 BW #2 Film	\$ 44.00
	N10BW2	Ten Window BW #2 Film	\$ 33.00
	N10BW3	Ten Window BW #3 Film	\$ 33.00

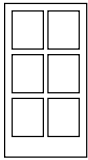

CLEAR POCKET MOUNT

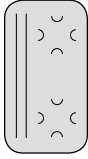

NOTCHED MOUNT

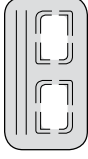

OPEN WINDOW MOUNT

FILM MOUNT CROSS REFERENCE CHART

TPC			CASTERM		RINN			FLOW		ADA
POCKET	NOTCHED	WINDOW	POCKET	POCKET	POCKET	NOTCHED	WINDOW	NOTCHED	WINDOW	WINDOW
CP102U			N.A.	N.A.	20-0102					
CP8 PEDO			108 PEDO		N.A.			N.A.		N.A.
CP1C	N1H2	W1H2			20-1018	25-0178	30-6011	23200	601-200G	22004
	N2H0	W2H0			20-1024	25-0811	30-4021	23608	402-608G	22616
CP2H	N2H2	W2H2	102H		20-1020	25-0179	30-6021	23203	602-203G	22020
	N2H3	W2H3			20-1023	25-0180	30-7021	N.A.	702-206G	22061
	N4H0	W4H0			20-1044	25-0187	30-4040	23609	404-609G	22624
CP4C	N4H2	W4H2	104C		20-1048	25-0181	30-6040	23209	604-209G	22103
CP4H			104H		20-1040	25-0815	30-6045	23239	6045-239G	22152
CP4H2V	N4H2V2	W4H2V2	106HV		20-1062	25-1061	30-6062	23216	606-216G	22202
CP6H	N6H2	W6H2	106H		20-1060	25-0182	30-6061	23215	606-215G	22194
CP8C	N8H2	W8H2	108C		20-1088	25-0825	30-6081	23219	608-219G	22251
CP10C			110C		20-1108	N.A.	30-6101	23220	610-220G	22285
CP8H6V	N8H6V2	W8H6V2	114HV		20-1142	25-0184	30-6141	23225	614-225G	22335
CP12H6V	N12H6V2	W12H6V2	116-118HV		20-1182	25-0187	30-6180	23228	618-268G	22400
CP10C	N10BW2	W10BW2	110C		20-1108	25-0821	30-2345	23261	610-261G	22558
	N10BW3				N.A.	25-0820	30-3456	23262	N.A.	N.A.
		W20BW2			80-0138	N.A.	30-4567	N.A.	618-230G	22574

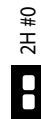
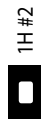
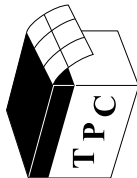

3-Way Syringe



Part No.	Description	Retail
#TPC3WAY	3-way syringe	\$42.00
#52046-TPC	Replacement Cartridge (2pcs per pack)	\$11.00

- 360° tip rotation
- Accurate air and water control
- Autoclavable quick disconnect aerator tip

3-Way Syringe Push Ring



Part No.	Description	Retail
TPC3WAY-PR	3-way syringe	\$53.90
#52046	Replacement Cartridge (2pcs per pack)	\$11.00

- 360° tip rotation
- Accurate air and water control
- Autoclavable quick disconnect aerator tip
- Quick connect push ring.

Autoclavable 3-Way Syringe Tip



Part No.	Description	Retail
#M7500	Autoclavable 3-way syringe tip (box of 100) (compatible with DCI 3-way syringe)	\$230.00/Box

- syringe tip only
- box of 100

Shipping Dimensions: 6"L x 4"W x 2"H / 2 lbs.

Deluxe Autoclavable Valve

Autoclavable High Vacuum Valve – Short



Part No.	Description	Retail
#P2330	Deluxe Autoclavable high volume ejector–short	\$33.00
#P2166	Replacement Deluxe HVE lever & spool	\$11.00

- Autoclavable valve
- Finger tip lever control for on/off flow
- Swivel quick disconnect for 360° rotation
- Adapts to 1/2" ID vacuum tubing
- Disconnect at swivel for simple autoclaving
- Anodized aluminum one piece valve body construction with anodized aluminum swivel

Autoclavable High Vacuum Valve – Long



Part No.	Description	Retail
#P2335	Deluxe Autoclavable high volume ejector–long	\$35.00
#P2166	Replacement deluxe HVE lever & spool	\$11.00

- Autoclavable valve
- Ultra smooth lever control for on/off flow
- Swivel quick disconnect for 360° rotation
- Adapts to 1/2" ID vacuum tubing
- Disconnect at swivel for simple autoclaving
- Anodized aluminum one piece valve body construction with anodized aluminum swivel

Autoclavable Saliva Ejector Valve



Part No.	Description	Retail
#P2340	Deluxe Autoclavable saliva ejector valve	\$27.00
#P2169	Replacement deluxe saliva ejector lever & spool	\$11.00
#P2185	Replacement deluxe saliva ejector rubber tip <u>only</u> (5 pcs/Bag)	\$9.90/Bag

- Autoclavable valve
- Ultra smooth lever control for on/off flow
- Swivel quick disconnect for 360 degree rotation
- Disconnect at swivel for simple autoclaving
- Anodized aluminum one piece valve body construction with anodized aluminum swivel



Curing Bulb

- 12 Volt 75 Watt
- Power Light 100
- Replacement for PL100

#P201 \$ 29.00



Operator Light Reflector

- Quality coated glass
- No core charge
- Original factory OEM specifications
- Replacement reflector for Belmont®, LSM® and Celux lights

#P705 \$ 160.00



Scaler Tubing 30K without Connector

- 30KHz 3-wire handpiece assembly
- Silicone jacket

#S8002 \$ 100.00



Scaler Tubing 25K without Connector

- 25KHz 3-wire handpiece assembly
- 7' length

#S8001 \$ 100.00



Mini HP Control Block

- Mini control block for 3 handpieces
- Solid brass construction
- Extra mounting holes allow a variety of placements
- 10-32 threaded barbs
- Longest lasting inter-woven diaphragm
- High flow design

#52003 \$100.00

#52004 Diaphragm \$10.00



Water Bottle System

- 750 ml Extra Heavy duty bottles
- Easy to read pressure gauge
- Pre-set integrated regulator
- Ideal for bactericidal solutions
- Post clamp
- Will mount to vertical surface

#W5030 \$125.00

#W5035 - 750 ml bottle only \$6.00

#W5040 - 1000 ml bottle only \$18.00



Flow Control Valve

- Chrome plated brass

#52007 \$ 15.50



Momentary Valve

- Chrome plated brass

#52008 \$ 13.00



On/Off 2-Way Valve

- Chrome plated brass

#52009 \$ 13.00



On / Off 3 Way Valve

- Chrome plated brass
- #52010 \$ 13.90



Check Valve

- Chrome plated brass
- #52019 \$ 9.50



Routing Valve

- Chrome plated brass
- #53014 \$ 15.00



Non-Retraction Water Relay Valve

- Chrome plated brass
 - Equivalent to DCI #7068
- #52011 \$ 33.00



4-hole Adapter, Metal

- Quality plated brass
- #52039 \$ 8.00



Plated Brass Nut 4-hole Midwest

- Brass extends HP thread life
 - Standard connector
- #52040 \$ 3.50



HP Tubing Adapter, 2 - hole HP to 4-hole Tubing

- Adapts 2 hole HP to 4-hole tubing
- #52041 \$ 39.00



HP Tubing Adapter, 4-hole HP to 2 -hole Tubing

- Adapts 4-hole HP to 2-hole tubing
- #52042 \$ 39.00



Stainless Steel Tray

- Premium quality stainless steel
 - Size 13F (9-3/4" x 13-1/2")
- #52026 \$ 39.00
#52027 Skid Pad \$3.16

Parts



Female Quick Disconnect

- Panel mount with auto shut-off
- 1/4" poly-flow rear connection
- Chrome plated brass
- 1/4" Coupler

#53012 \$ 15.00



Male Quick Disconnect w/ Shut-off

- With auto shut-off
- 1/4" poly-flow rear connection
- Chrome plated brass
- 1/8" Male QD

#53042 \$ 11.50



Male Quick Disconnect w/ Shut-off

- With auto shut-off
- 3/8" poly-flow rear connection
- Chrome plated brass
- 3/8" male QD

#53043 \$15.70



1/4" Coupler with shut off

- barb type
- Chrome plated brass
- Equivalent to DCI #0006

#53047 \$ 10.00



Foot Control, Wet/Dry

- Precision-touch disc foot control with wet/dry toggle
- Weighted for maximum stability
- Durable chrome steel dome
- Smooth, variable pressure control
- Non-skid foot pads

#53200 \$ 95.00

#53200-TS Toggle (only) \$1.60

#53121 Toggle assembly \$19.90



Foot Control, Shrouded

- Large stable base with shroud
- Precision-touch disc foot control
- Weighted for maximum stability
- Durable chrome steel dome
- Smooth, variable pressure control
- Non-skid foot pads

#53117 \$ 65.00



4 Hole HP Straight Asepsis Assembled

- Assembled with metal adapter / nut
- Silicone Jacket
- 5.5' length

#52036 \$25.00



Syringe Tubing

#52038 \$16.50

- 6' Silicone Jacket tubing



Air Electric Switch

- Normally open air switch
- 15 PSI activated Check this spec

#A800N-SW \$ 19.00

Parts



53016-S

53016-L

Disposable Amalgam Traps

- 53016-S-100 1 7/8" Clear
 - 53016-L-100 2 1/8" Clear
 - Clear trap pkg of 100
- #53016-S-100 **\$45.00**
 #53016-L-100 **\$45.00**



Solids Collector Canister

- Includes: Lid, Base, o-ring
 - Bottom ported 2015 unit
 - 2 1/8" trap
- #53008 **\$42.00**



Solids Collector Canister

- Includes: Lid, Base, o-ring
 - Side ported for 3550 unit
 - 2 1/8" trap
- #53008-R **\$42.00**



Solids Collector Canister

- Includes: Lid, Base, o-ring
 - Bottom ported, 2600 unit
 - 1 7/8" trap
- #53008-2600 **\$42.00**



Nylon Bushing

- #LP-RI-S **\$20.00**
- OD 1 7/8"
 - ID 1 3/8"



Nylon Bushing

- #LP-PC-L **\$20.00**
- OD 1 7/8"
 - ID 1 11/16"



Chair Adaptor

- #TPCRDSBKT **\$ 320**
- TPC Mirage swing mount chair bracket



Chair Adaptor

- #L2000-BKT **\$ 270**
- Laguna chair bracket

48" Light Post

- #LP48 **\$149.00**
- 48" light post
 - LP-PC-L included
 - Optional: LP-RI-S



Chair Adaptor

- #BELBRKT **\$ 165.00**
- Belmont Chair Bracket
 - Fits Bel 20 and 50 chairs



Chair Adaptor

- #TPCBRKT **\$ 270**
- TPC chair bracket
 - RT handed setup



Chair Adaptor

- #TPCBRKT -L **\$ 270**
- TPC chair bracket
 - LF handed setup

Custom Umbilical Lengths / Utility Center

2000 / 2015 Umbilical

- 1 (6 X 4) MM Air "Yellow"
 - 1 (6 X 4) MM Water "Blue"
 - 4 (4 X 2.7mm)
 - Yellow
 - Grey
 - Purple
 - Red
 - 1 (5/8") Drain Line
 - 1 (5/8") Cuspidor Drain 2000 unit
 - 1 (2") Umbilical
 - No Electrical / Low Voltage
- #2015-UMB-FT **\$ 31.50**
 #2015-UMB-10 **\$283.50** 10' length

3500 Umbilical

- 1 (6X4) MM Air "Black"
 - 9 (4 X 2.7mm)
 - Yellow
 - Grey
 - Purple
 - Red
 - Green
 - Blue
 - Maroon
 - Black (spare)
 - Red (spare)
 - No Low Voltage
- #3500-UMB-FT **\$ 31.50**

3550 Umbilical

- 1 (6X4)mm Air "Yellow"
 - 1/2" Sprial Loc Tubing
 - Syringe tubing.
- #3550-UMB-FT **\$19.00**

MC500 / 501 Umbilical

- 1 6X4MM Air "Black"
 - (1 1/2") Umbilical
 - 8 4 X 2.7mm
 - Yellow
 - Grey
 - Red
 - Green
 - Blue
 - Maroon
 - Black (spare)
 - Red (spare)
 - Purple (spare)
 - 1/2" Sprial Lock Suction
 MC501 only Add
 \$2.62 per ft
 - Low Voltage
- #MC500-UMB-FT **\$ 31.50**

OMC2375 Umbilical

- 1 6X4MM Air "Yellow"
 - 1 (1 1/2") Umbilical
 - 8 4 X 2.7mm
 - Yellow
 - Grey
 - Clear
 - 5/8" Sprial Lock Sction
 - No Electrical
- #OMC2375-UMB-FT **\$ 32.00**

MS3000 / MR4000

- 1 6X4mm Air "Black"
 - 8 4 X 2.7mm
 - Yellow
 - Grey
 - Red
 - Green
 - Blue
 - Maroon
 - Black (spare)
 - Red (spare)
 - Purple (Spare)
 - No Low Voltage
- #3000-UMB-FT **\$ 31.50**

Junction Box

- 12.5" X 12.5"
 - Metal frame
 - Plastic top cover
- #53120 **\$105.00**



Master Shut-Off Valve

- Includes air / water valved
 - 3/8" compression tube
 - Includes pressure regulator
 - Includes pressure guage
- #53119 **\$204.76**



Rebulid Kit for 53119

- Diaphram
 - Spring
 - Plunger
- #53099 **\$13.00**



40 micron filter

- Use for air and water
 - 40 micron filter element
- #53107 **\$2.10**



Raw Tubing per Ft.

Part Number	Description	Price per Ft
53096	1/2 Grey Sprial Lock Tubing	\$3.00 Per Ft
53093	5/8" Clear Sprial Lock Tubing	\$3.00 Per Ft
53085	5/8" Grey Sprial Lock Tubing	\$3.00 Per Ft
53021	2" Umbilical Tubing	\$6.20 Per Ft
2000-HVETubing	1/2" Smooth HVE tubing	\$2.50 Per Ft
2000-SETubing	Saliva Ejector Tubing	\$1.30 per Ft

Corporate Staff Contacts

Customer Care (8:00 a.m. – 5 p.m. PST)
Customer Service Fax Orders

1-626-810-4337
1-626-810-4245



Scott Beckley
Vice President Sales
sbeckley@tpcdental.com



Mike Carlone
Service / Repair Manager
mcarlone@tpcdental.com



Holly Han
Shipping Manager
holly@tpcdental.com



Ryan Kong
Customer Service
customerservice@tpcdental.com



Alfonso Sanchez
Latin American Sales
alfonso@tpcdental.com



Charlie Chuck
Handpiece Specialist
charles@tpcdental.com

Jeff Lliscano
Technical Support
jliscano@tpcdental.com

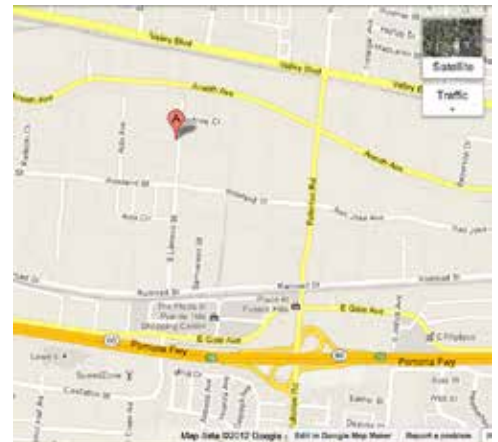

851 S. Lawson St. • City of Industry, CA
91748
Tel. (800) 560-8222 • Fax (626) 810-4245

Upholstery Color Selection

Nagua Soft Upholstery



PR 40 Black Satin



PR 51 Cocoa

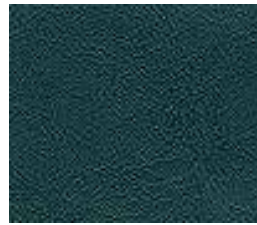

PR 49 Deep Sea



PR 44 Cream



PR 47 Tapestry Red



PR 50 Lake Louise



PR 37 Feather



PR 35 Fawn

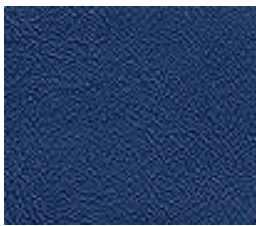

PR 55 Deep Sapphire



PR 48 Doeskin



PR 38 Harness



PR 53 Ivy



PR 46 Blue Fog

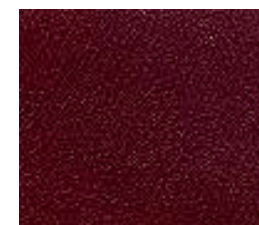

PR 36 Cabernet



PR 43 Velvet Brown

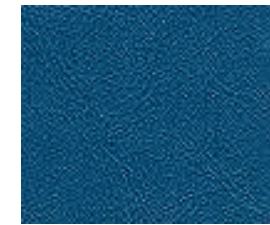

PR 54 Mallard Blue



PR 45 Mint Leaf



PR 41 Mulberry



PR 39 Laurel



PR 42 Rose Blush

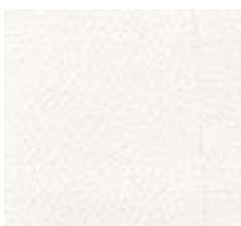

PR 34 Soft White



PR 52 Saddle

Stocked (highlighted) Nauga Soft Upholstery Charges:

Dental Chair:	\$200.00
Assistant Stool:	\$150.00
Doctor Stool:	\$130.00

PR 37, 47, 40, 49, 50, 51

Non-Stocked Nauga Soft Upholstery Charges:

Dental Chair:	\$450.00
Assistant Stool:	\$150.00
Doctor Stool:	\$130.00

Upholstery Color Selection



Maive
DU-03



Desert Rose
DU-06



Purple Grey
DU-07



Dusty Jade
DU-11



Wedgewood
DU-14



Grey Teal
DU-15



Taupe
DU-18



Greystone
DU-19



Black
DU-100



Cobalt
DU-116



Atlantis
DU-201



Autumn
DU-202



Tumbleweed
DU-210



Cinnamon
DU-213



Stormy
DU-220

TPC recommends final upholstery color to be selected from actual color swatch chart.



TPC

TPC Advanced Technology, Inc.

851 S. Lawson St. • City of Industry, CA 91748

Tel. (800) 560-8222 • Fax (626) 810-4245

tpcdental.com